



Magnetic Inductive

Flow Sensor **InduQ**[®]

Series VMM



Table of contents	page
0 About this operating manual.....	4
1 Device description	5
1.1 Delivery, unpacking and accessories	6
1.2 Intended use.....	7
1.3 Exclusion of liability	7
2 Safety instructions.....	8
3 Construction and function	9
3.1 Construction.....	9
3.2 Measuring principle	10
3.3 Functions.....	10
4 Installation of VMM.....	10
4.1 Installation instructions display electronics	11
4.2 Instructions on potential equalisation and cathode protection	12
4.2.1 Potential equalisation	12
4.2.2 Cathodic protectives	13
4.3 Sensor installation instructions.....	14
4.4 Mounting.....	16
5 Electrical connection.....	17
5.1 Mains and signal cable.....	17
5.2 Electrode and magnetic current line.....	19
6 Commissioning.....	19
7 Operation	21
7.1 Functional classes (main menu).....	24
7.1.1 Measured values.....	25
7.1.2 Password	27
7.1.3 Totalizer	29
7.1.4 Measurement processing.....	30
7.1.5 Flow.....	31
7.1.6 Pulse output.....	34
7.1.7 Status output.....	36
7.1.8 Current output	37
7.1.9 Simulation	38
7.1.10 Self-test	40
7.1.11 Settings Sensor.....	42
8 Errors and returns	46
8.1 System errors.....	46
8.2 Self-test errors	47
8.3 Return shipment to the manufacturer	48

9	Cleaning, maintenance, storage	49
9.1	Cleaning.....	49
9.2	Maintenance	49
9.3	Storage	50
10	Disassembly and disposal.....	50
11	Technical data.....	51
11.1	Characteristics of the VMM.....	51
11.2	Materials.....	53
11.3	Dimensions and weights	54
11.3.1	Compact device	54
11.3.2	Separate version (with wall bracket).....	55

induQ® is a registered trademark of SIKA Dr. Siebert & Kühn GmbH & Co. KG.

Copyright notice:

The reproduction, distribution and utilization of this operating manual as well as the communication of its contents to others without express authorization is prohibited. Offenders will be held liable for the payment of damages. All rights reserved in the event of the grant of a patent, utility model or design.

0 About this operating manual

- The operating manual is aimed at specialists and semi-skilled personnel.
- Before each step, read through the relevant advice carefully and keep to the specified order.
- Thoroughly read and understand the information in the section "Safety instructions".

If you have any problems or questions, please contact your supplier or contact us directly at:



Dr. Siebert & Kühn GmbH & Co. KG
 Struthweg 7-9 • D - 34260 Kaufungen
 ☎ +49 5605 803-0 • 📠 +49 5605 803-555
 info@sika.net • www.sika.net

Hazard signs and other symbols used:



DANGER! Danger to life due to non-observance!
 This sign indicates dangers which could lead to serious health defects or to death.



WARNING! / CAUTION! Risk of injury!
 This sign indicates dangers that cause personal injuries that can lead to health defects or cause considerable damage to property.



CAUTION! Electric current!
 This sign indicates dangers which could arise from handling of electric current.



CAUTION! High temperature!
 This sign indicates dangers resulting from high temperature that can lead to health defects or considerable damage to property.



CAUTION! Material damage!
 This sign indicates actions which could lead to possible damage to material or environmental damage.



ADHERE TO OPERATING MANUAL!



NOTICE!
 This symbol indicates important notices, tips or information.



NO DOMESTIC WASTE!
 The device must not be disposed of together with domestic waste.



Pay attention to and comply with information that is marked with this symbol.



Follow the specified instructions and steps. Adhere to the given order.



Check the specified points or notices.



Reference to another section, document or source.



Item.

1 Device description

The induQ® of the VMM from SIKA is a flow sensor without moving parts. The measurement is performed using magnetic induction.

The VMM is used for measuring or dosing water and electrically conductive fluids. The complete measuring instrument comprises the sensor and the related display electronics.

The display electronics is microprocessor controlled and programmable. It can be customized using a control unit.

The basic configuration settings such as display electronics calibration are realized at the factory. Other settings are user definable.

Measurement data from sensors are processed by display electronics. It is designed for flow velocities up to 10 m/s.

Components:

The most important components of the VMM are

- ① Display electronics.
- ② Indication and control panel.
- ③ Sensor.
- ④ Measuring tube.
- ⑤ Junction box.
- ⑥ Process connection.



Versions:

The VMM is available as a compact device (→ Fig. left) or in separate design (→ Fig. right).

Both designs are available in nominal widths from DN 15 to DN 200 with different features.

Type plates:

The type plates you can find at the backs of evaluation electronics and sensor.

They contain the most important technical data of VMM.

1.1 Delivery, unpacking and accessories

All units have been carefully checked for their operational reliability before shipment.

- Immediately after receipt, please check the outer packaging for damages or any signs of improper handling.
- Report any possible damages to the forwarder and your responsible sales representative. In such a case, state a description of the defect, the type and the serial number of the device.
Report any in-transit damage immediately. Damage reported at a later date shall not be recognized.

Unpacking:

- ↪ Carefully unpack the unit to prevent any damage.
- ↪ Check the completeness of the delivery based on the delivery note.

Scope of delivery:

- 1x VMM according to the order data.
- 1x operating manual.
- certificates (optional)



IMPORTANT!

- ↪ Use the type plate to check if the delivered unit corresponds to your order.
- ↪ In particular, for devices with electrical components, check to see if the correct power supply voltage is specified.

Accessories:

Installation supplies (gaskets/seals, screws, etc.) are not included with the delivery.

- Earthing rings.
- Protection rings.
- Sensor cable.

You can find details on the accessories in our catalogue on the Internet.

1.2 Intended use

Magnetic inductive flow sensor VMM is only intended to be used for measuring and dosing / batching the flow of electric conductive, liquid media

According to the Pressure Equipment Directive 2014/68/EU, only Group 2 fluids are permitted to be used.

Due to the magnetic field, the device can be used to measure flow rates up to 10 m/s (32.8 ft/s) and a minimum conductivity of 50 $\mu\text{S}/\text{cm}$, when using a synchronized static field.

WARNING! No safety component!



The flow sensor of the series VMM is not a safety component in accordance with Directive 2006/42/EC (Machine Directive).

↳ Never use the VMM as a safety component.

The operational safety of the device supplied is only guaranteed by intended use. The specified limits (→ § 4.3 "Sensor installation instructions") may under no circumstances be exceeded.

Before installing the device, check if the wetted materials of the device are compatible with the media being used (→ § 11.2 "Materials").

CAUTION! Risk of injury due to high temperature!



Hot process media can lead to hot surfaces! Danger of burns with surface temperatures above 70 °C.

↳ Take suitable protective measures, e.g. contact protection.

↳ The contact protection must be devised so that the maximum ambient temperature on the device is not exceeded.

Flow tube empty (partially filled). / Conductivity too low:



Faulty measurements can occur if the flow tube of the VMM is empty or partially filled or if the conductivity of the fluid being used is too low.

↳ Make sure that the flow tube of the VMM is always completely filled (→ § 4.3 "Sensor").

↳ Please observe the function "Empty pipe detection" (→ p. 10).

↳ Make sure that the fluid being used has a conductivity of at least 50 $\mu\text{S}/\text{cm}$.

Before ordering and installing, check that the device is suitable for your application.

1.3 Exclusion of liability

We accept no liability for any damage or malfunctions resulting from incorrect installation, in-appropriate use of the device or failure to follow the instructions in this operating manual.

2 Safety instructions



Before you install the VMM read through this operating manual carefully. If the instructions contained within it are not followed, in particular the safety guidelines, this could result in danger for people, the environment, and the device and the system it is connected to.

The VMM corresponds to the state-of-the-art technology. This concerns the accuracy, the operating mode and the safe operation of the device.

In order to guarantee that the device operates safely, the operator must act competently and be conscious of safety issues.

SIKA provides support for the use of its products either personally or via relevant literature. The customer verifies that our product is fit for purpose based on our technical information. The customer performs customer- and application-specific tests to ensure that the product is suitable for the intended use. With this verification all hazards and risks are transferred to our customers; our warranty is not valid.

Qualified personnel:

- ⚠ The personnel who are charged for the installation, operation and maintenance of the VMM must hold a relevant qualification. This can be based on training or relevant tuition. The personnel must be aware of this operating manual and have access to it at all times.
- ⚠ The electrical connection should only be carried out by a fully qualified electrician.

General safety instructions:

- ⚠ In all work, the existing national regulations for accident prevention and safety in the workplace must be complied with. Any internal regulations of the operator must also be complied with, even if these are not mentioned in this manual.
- ⚠ Degree of protection according to EN 60529:
Ensure that the ambient conditions at the site of use does not exceed (comply with) the requirements for the stated protection rating (→ § 11.1 "Characteristics of the VMM").
- ⚠ Take appropriate measures to ensure that the medium does not freeze.
- ⚠ Only use the VMM if it is in perfect condition. Damaged or faulty devices must be checked without delay and, if necessary, replaced.
- ⚠ When fitting, connecting and removing the VMM use only suitable, appropriate tools.
- ⚠ Do not remove or obliterate type plates or other markings on the device, as otherwise the warranty is rendered null and void.

Special safety instructions:**Danger! Electric current!**

Particular care must be taken if the front window of the housing becomes fogged over or discoloured because moisture, water or product might seep through the wire sheath into the terminal compartment in the housing!

- ⚠ Ingress protection IP67 is only achieved if suitable and tightly screwed down cable glands or conduits are used. If the cable glands are only tightened manually water may leak into the terminal compartment in the housing.
- ⚠ Electromagnetic compatibility is only achieved if the electronics housing is closed. Leaving the enclosure open can lead to electromagnetic disturbances.

Further warnings that are specifically relevant to individual operating procedures or activities can be found at the beginning of the relevant sections of this operating manual.

3 Construction and function

3.1 Construction

The VMM comprises a sensor and the display electronics. The sensor is used to measure fluid media. The display electrodes generate the coil current required for the magnetic field and prepares the induced voltage applied to the electrodes.

The VMM does not need any moving parts to make measurements. The inside of the measuring tube is completely open, allowing the fluid to flow unhindered through the measuring tube.

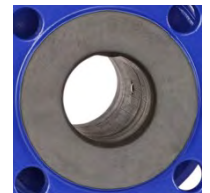
**Display electronics:**

The display electronics has a backlit LCD. 6 buttons are used for operation. That facilitates easy configuration of the display electronics. Furthermore the display electronics has an analogue 0/4 ... 20 mA current output, a pulse or frequency output and a status output.



3.2 Measuring principle

The magnetic inductive flow sensor operates on the inductive principle, i.e., a direct current is generated by the movement of a conductor in a magnetic field:

The measuring pipe of the VMM is in a magnetic field (B).

An electrically conductive medium (Q) passes through the pipe. During this, the positive and negative load carriers are inversely deflected.

A voltage arises which is perpendicular to the magnetic field, which is tapped through both electrodes.

The voltage induced during this is proportional to the average flow velocity of the fluid.

The electronics of the VMM converts the induced voltage into a flow-proportional frequency signal.

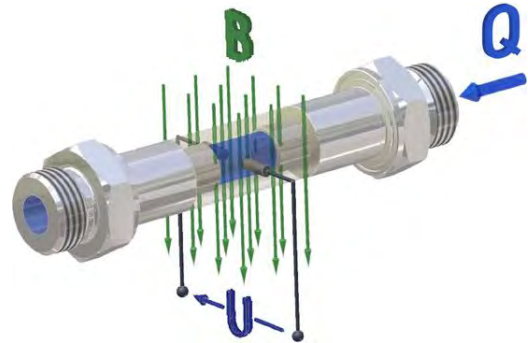

3.3 Functions

Empty pipe detection:

The electronic display unit has the ability for an empty pipe detection, which can be activated and deactivated.

The operating reliability depends on the conductivity of the liquid medium and the cleanliness of the electrodes.

As higher the conductivity is, as more reliable operates the empty pipe detection.

Insulation coatings on the electrodes surface worsen the empty pipe detection.

Safety of operation:

A comprehensive self-monitoring system ensures maximum safety of operation.

- Potential errors can be reported immediately via the configurable status output. The corresponding error messages will also be displayed on the display of the display electronics. A failure of the auxiliary power can also be detected via the status output.
- All outputs are electrically isolated from the auxiliary power, the sensor circuit and from each other.

4 Installation of VMM

Before installing, check that

- the wetted materials of the device are suitable for the liquid being used (→ § 11.2 "Materials").
- the equipment is switched off and is in a safe and de-energised state.
- the equipment is depressurised and has cooled down.
- Please observe in particular "Instructions on potential equalisation and cathode protection" (→ § 4.2).



Suitable tools:

- ☞ Use only suitable tools of the correct size.

4.1 Installation instructions display electronics

Compact version (standard):

For the compact version the display electronics housing is mounted on the sensor. Therefore no cable is necessary between sensor and display electronics.

Remote version (optional):

The display electronics needs to be mounted separately from the sensor if:

- the mounting area is difficult to access or there is a lack of space,
- medium and ambient temperatures are extremely high,
- there is strong vibration.

The display electronics has to be mounted free of vibrations!

- ↪ Make sure that the cables are properly installed at high humidity and wet conditions.
- ↪ The electrode cable must be fixed. If the conductivity of the medium is low, cable movements may change the capacity considerably and thus disturb the measuring signal.
- ↪ Do not lay the cables close to electrical machines and switching elements.
- ↪ Equipotential bonding must be ensured between sensor and display electronics.

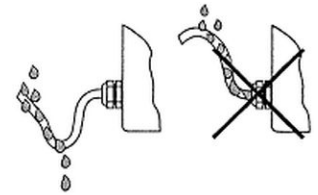

IMPORTANT! Pay attention to the maximum cable length!

For the separate version, the minimum permissible conductivity of the medium is determined by the distance between the sensor and the display electronics.

The maximum cable length to ensure accuracy is 200 m (→ p. 17 "Connecting cables").

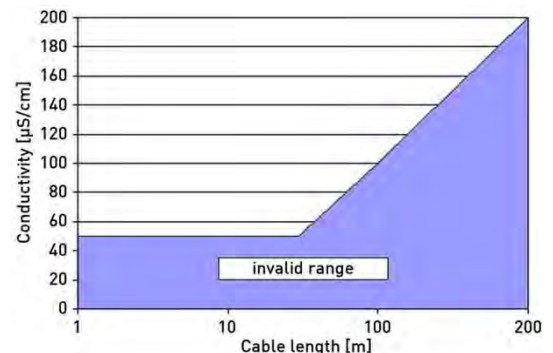

4.2 Instructions on potential equalisation and cathode protection

4.2.1 Potential equalisation

The signal outputs (process outputs and the mains supply of the VMM are galvanic isolated from each other. The housing and the interference filter of the mains supply are connected to PE.

The electrodes and measuring electronics are related to the potential of the function earth FE of the sensor. FE is not connected to PE, but may be connected with each other in the sensor junction box. If the sensor is grounded by using ground disks (earthing rings), these must in connected with the function earth FE.

At a separate assembly of sensor and display electronics the outer screen of the connecting cable is connected to the housing of the display electronics and has PE potential. The inner screens of the electrode line are connected to FE inside the junction box of the sensor and to the mass (GND) of the display electronics.

Details of all wirings, terminals and drawing can be found in § 5 "Electrical connection".



IMPORTANT!

The display electronics can only process the measuring signal interference-free if this voltage is referenced to a fixed potential (earth).

Potential equalisation on electrically conductive pipes:

The sensor is electrically connected to the pipeline in the sense of a potential equalisation.

Thus, the pipeline is earthed, and the media and therefore the signal voltage have a solid signal common.

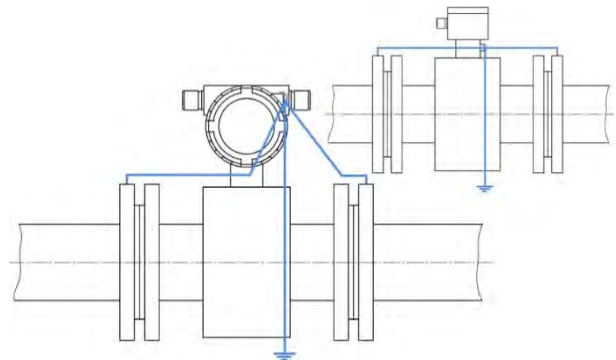

Potential equalisation on electrically insulated pipes:

When using pipes lined with electrical insulation, plastic tubing or concrete conduits, a separate earthing washer is used to earth the measuring media. The earthing washer is installed between the pipeline connection and the sensor's flange and the ring's inside contacts the media. Contrary to the diagram shown below, one earthing washer on the inflow side is sufficient.

If bidirectional measurements are to be taken, one earthing washer must be installed on either side.

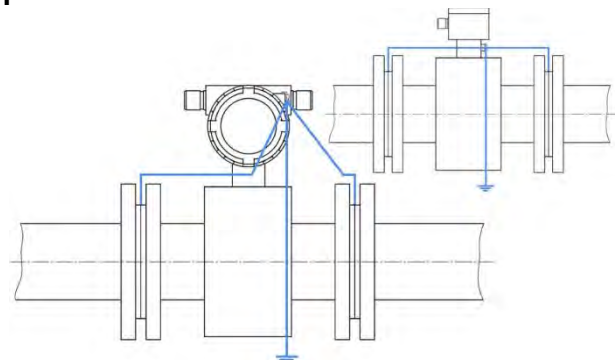

Protection washers or protection rings can also be used as earthing component; or special earthing electrodes, incorporated in the sensor, may be installed.

Earthing electrodes are more economical than earthing washers. However, it must be ensured that noticeable differences in potential within the equipment are eliminated, otherwise the earthing electrodes will electrolyze and be destroyed.

Potential-free installation of the sensor:

If the pipelines cannot be earthed, due to operational reasons, the sensor must be installed voltage free. To do this, a separate cable must be used to electrically connect these segments of the pipeline (min. 6mm²).

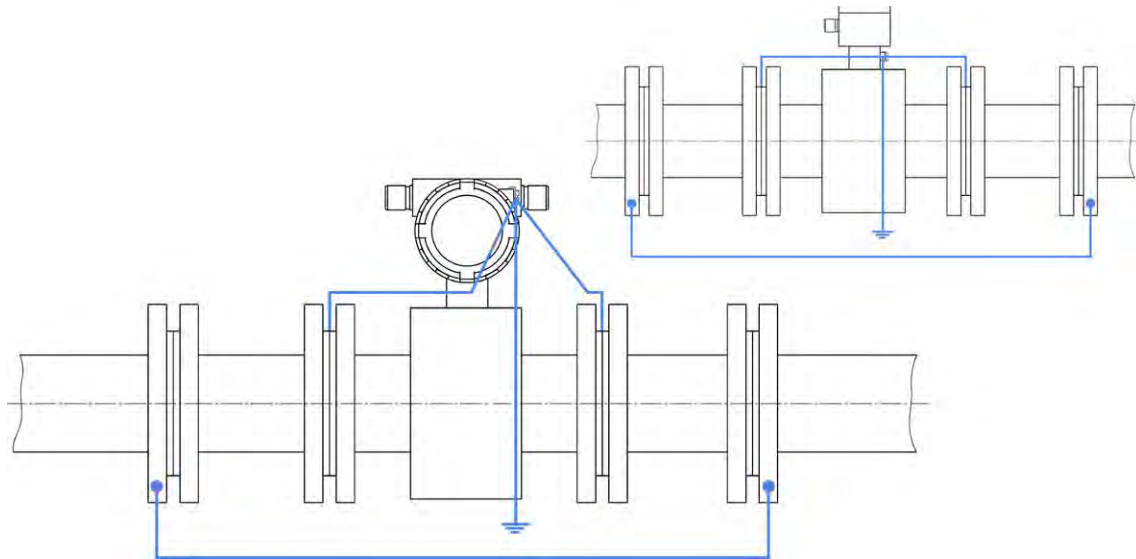

An electrical connection occurring between the sensor and any material used for the installation must be avoided. Insulating segments must be installed between the sensor and the pipeline (e.g. PVC pipes or similar).

Subsequently, earthing washers are used to electrically connect the media with the display electronics. The display electronics must not be connected with the protective earth conductor. This may only be done, if the auxiliary power is 24 V_{DC}.

Potential equalisation in separate design:

Create the potential equalisation in the separate design the same as described in the above sections. For the potential equalisation, the display electronics and the sensor are connected to each other through Pin 7 of the connecting cable.

4.2.2 Cathodic protectives

Using a cathodic protective unit to avoid corrosion, which put a voltage to the tube wall, it must be connected to terminal FE. The boards, control panel and internal switches of the display electronics are on the same potential as FE.

CAUTION! Electric current - comply with limits!

According to EN 61010-1:2012 all electrical circuits with „protective safety isolation without any protection against contacts” must observe the following maximum voltages:



- Maximum AC voltage (V_{eff}) 33 V
- Maximum DC voltage 60 V.

↳ Make sure that no higher potential is connected to FE.

4.3 Sensor installation instructions



CAUTION! Risk of malfunction due to external magnetic fields!

Magnetic fields close to the device can cause malfunctions and should be avoided.

- Ensure that no external magnetic fields are present at the installation site of the VMM.

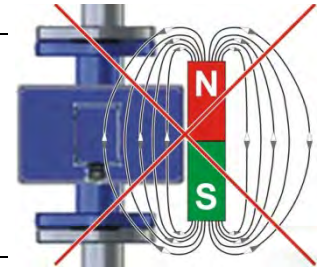

Please observe § 1.1 "Delivery, unpacking and accessories" and the following installation instructions:

General:

- The VMM can always be installed at any point on the pipeline in the horizontal as well as in vertical sections. Ideally, the sensor should be installed in a pipeline with a sufficient straight run, both before and after the measuring point.

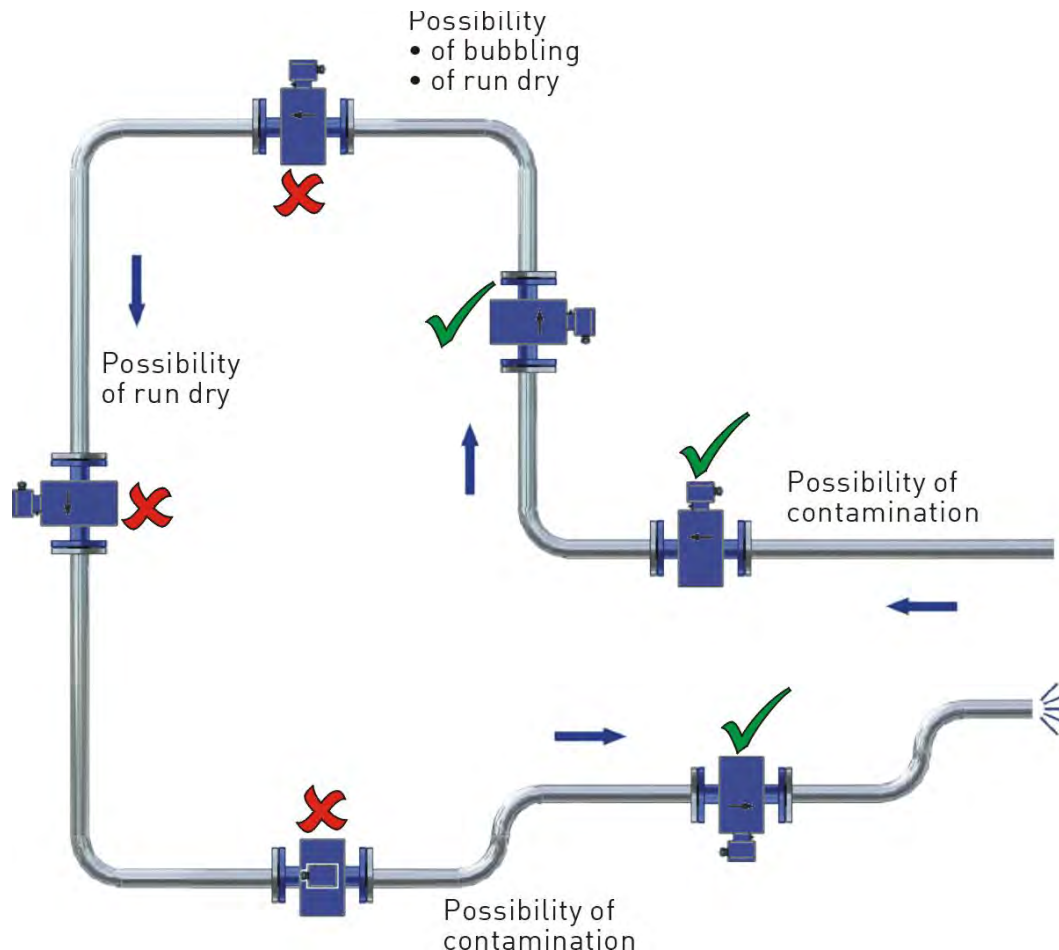

- Basically, the measuring principle does not depend on the flow profile. You should use straight inlet and outlet sections according to the nominal width (DN). An inflow path of 5 x DN and an outflow zone of at least 2 to 3 x DN is required.
- The flow sensor is only suitable for application in completely filled pipe systems. With a free pipe outlet, the sensor should not be installed in pipe sections that could run empty (e.g., downpipes).

If the sensor must be installed in a down pipe, ensure that portion of the pipeline is always filled 100% with the media.

- Due to possible accumulation of gases, the sensor should not be installed at the highest point of a pipeline.
- It must be ensured, that the axes of the electrodes are running horizontally to avoid erroneous measurements due to deposits or air bubbles on the electrodes.

Also, note that in case of deviations from horizontal, the functioning of the Empty pipe detection (→ p. 10) is limited.

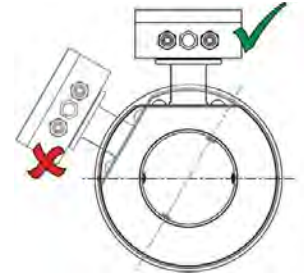

Installation in unfilled pipeline:

- If a pipeline is not always filled, or in case of an open channel (drainage), the sensor must be installed in a siphon. That means the flow tube cannot run dry and is always filled with measured medium.

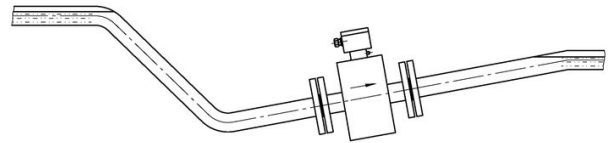

Installation between tees, valves and pumps:

Always maintain the distance of the pipe's straight run (Fig. 5). If these distances cannot be maintained, flow conditioners must be installed or pipes with smaller diameter must be used.

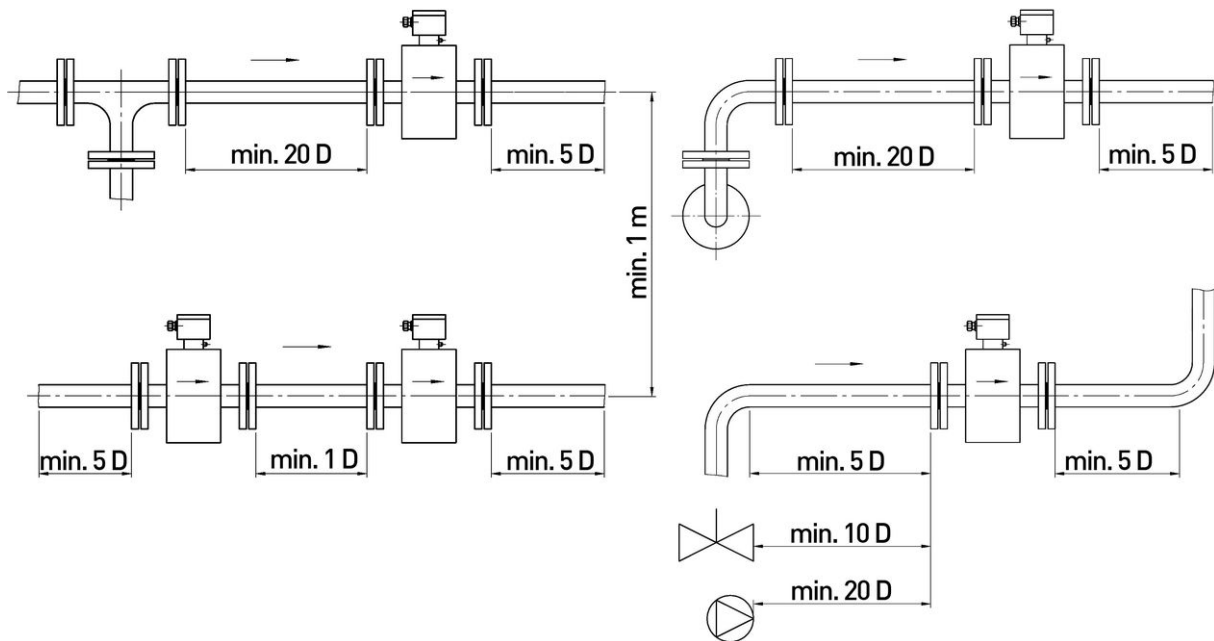

If several sensors are installed in series, the distance between each sensor must be equal to the length of one sensor. If two or more sensors are to be installed in parallel, the distance between sensors must be at least 1 m.

Measures during malfunctions:

In case of malfunctions in the inflow section due to vortexing (e.g. after pipe elbows, at tangential inclusions or with a half-open gate before the sensor), measures for normalisation of the flow profile are necessary.

The appropriate steps are:

- increasing the inflow and outflow zones
- using flow conditioners
- reducing the inner diameter of the pipe

4.4 Mounting

As a compact device, the VMM is installed directly into the pipeline. With the separate design, the sensor is installed in the pipeline. The display electronics can be attached to the wall with the bracket.

IMPORTANT NOTICES:

- Only use suitable gaskets for installation.
- Observe the flow direction indicated on the type plate and on the back side of the sensor.
- Observe the mounting dimensions (→ § 11.3 "Dimensions and weights").

- ↪ Select an appropriate location for installation (→ § 4.3 "Sensor installation instructions"). To ensure the best possible measuring accuracy, a vertical installation position with increasing flow is preferable (no collecting of dirt deposits).
- ↪ Install the appropriate screwed connections at the installation location.
- ↪ Insert the VMM together with the gaskets.
- ↪ Connect the flange connections corresponding to the requirements of their use.

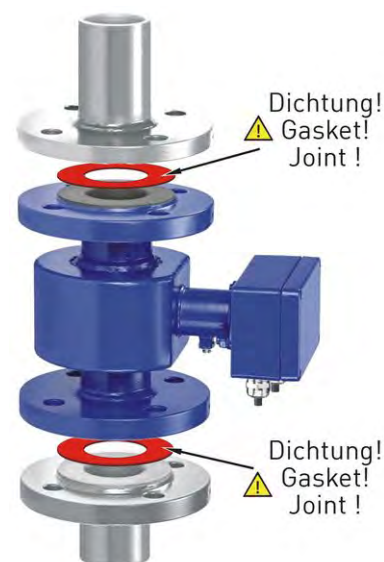
**WARNING! Risk of injury or material damage!**

Incorrect gaskets and connection materials plus improper assembly can lead to injuries or material damage.

- ↪ During installation, comply with the requirements that result from your application.
- ↪ Maintain the required tightening torques.

**IMPORTANT! Weather protection required**

In the case of an outdoor installation, the device must be protected against direct solar irradiation with a weather shield.

5 Electrical connection



CAUTION! Electric current!

The electrical connection of the VMM should only be carried out by a fully qualified electrician.

➤ De-energize the electrical system before connecting the VMM.

Make the electrical connection of the VMM through the terminal strips in the interior of the display electronics.

For the separate design, the sensor cable for the electrodes and the magnetic current are required in addition. They are connected through the terminal strips in the junction boxes of the display electronics and the sensor.

Connecting cables:

When connecting the VMM, use the following cable depending on the cable lengths:

Cable length	Wire cross-section	Example
≤ 10 m	≥ 0.25 mm ²	LIYCY-CY TP 2x2x0.25 mm ²
> 10 m	≥ 0.75 mm ²	LIY-TPC-Y 2x2x0.75 mm ²

Cable ends dimension:

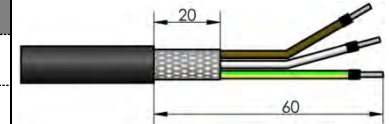

The cables are each twisted in pairs and shielded. In order to protect the cable from external interference, the pair wires are covered by an additional, overall shield.

The outer shield is grounded by means of special EMC-compliant cable glands at both ends of the cable.



IMPORTANT! Potential equalisation required!

➤ Comply with the instructions on Potential equalisation (→ § 4.2.1).

5.1 Mains and signal cable

The connection of the mains and signal cable are the same in both versions.

The terminal strips are located behind the rear housing cover.

- Screw the rear cover from the housing counter clockwise.
- Only use signal cables as specified in chapter "Connecting cables".
- Lay the signal cables separately from cables with voltages >60 V.
- Avoid laying signal cables close to large electrical installations.

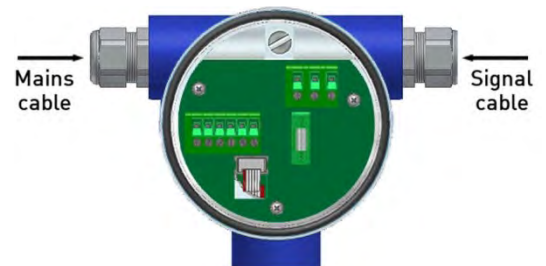

IMPORTANT! Pay attention to the clamping area of the cable gland!

To guarantee the protection class as per DIN EN 60529, the connection cable being used must have a sheathing diameter that matches the cable gland.

Terminal assignment:

Terminal	Label	Function	
		115 / 230 V _{AC}	24 V _{AC}
1	PE	Protective conductor	-/-
2	N	Neutral conductor	0 V
3	L	Phase	24 V
4	Pulse -	Pulse output (passive)	
5	Pulse +		
6	Status -	Status output (passive)	
7	Status +		
8	Current -	Current output (active / passive)*	
9	Current +		

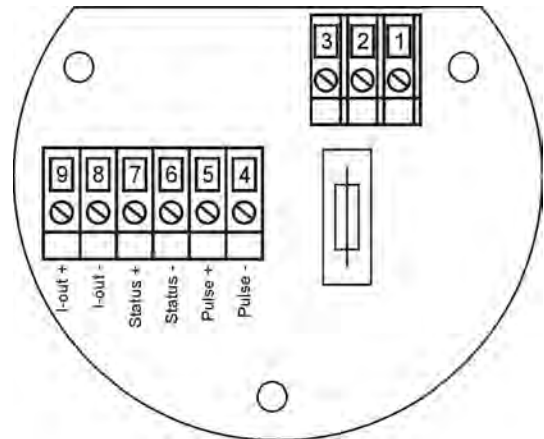

* permanently configured in factory.

Wiring pulse / status output (passive):

The external wiring for the pulse output and the status output is the same. The wiring for the pulse output is done via terminals 4 and 5 and for the status output via terminals 6 and 7.

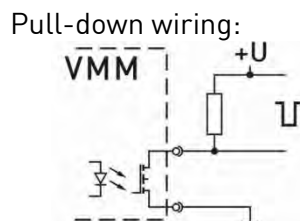
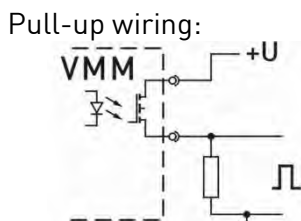

Switching values:

- U_N: 24 V
- U_{max}: 30 V
- I_{max}: 60 mA
- P_{max}: 1.8 W

Recommendation Pull-Up / Pull-Down resistance ~5 kΩ.

Wiring current output (passive):

An external voltage supply is required when connecting the passive current output.

Loop supply 12 ... 30 V

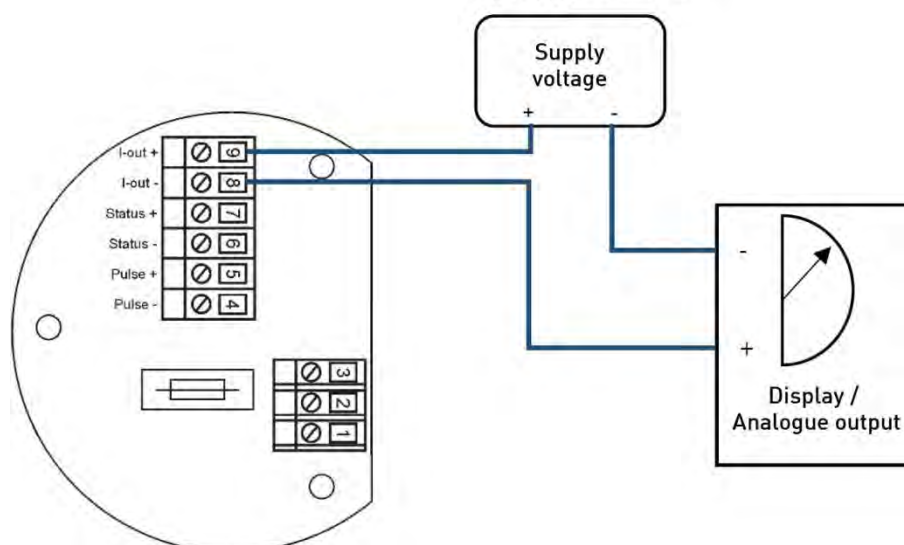

5.2 Electrode and magnetic current line

For the separate design, the electrodes and magnetic current cable must be connected in addition.



CAUTION! Electric current!

Do not connect or disconnect the field coil cable before the primary power of the meter has been disconnected!

Connect through the terminal strips in the junction boxes of the display electronics and the sensor.

Pin assignment:

Terminal	Wire colour	Function
Magnetic current line (3 wire)		
5	brown	Magnetic field current 1
6	white	Magnetic field current 2
7	green-yellow	Potential equalization / PE
Electrode line (5 wire*)		
22	red	Measuring ground
23	brown	Electrode 1
24	white	Electrode 2

* The wires green-yellow and blue are not connected.

- ↪ Only use cables as specified in chapter "Connecting cables".
- ↪ The outer shield is grounded by means of special EMC-compliant cable glands at both ends of the cable.
- ↪ The inner shields are connected to terminal 7 and 22 respectively.

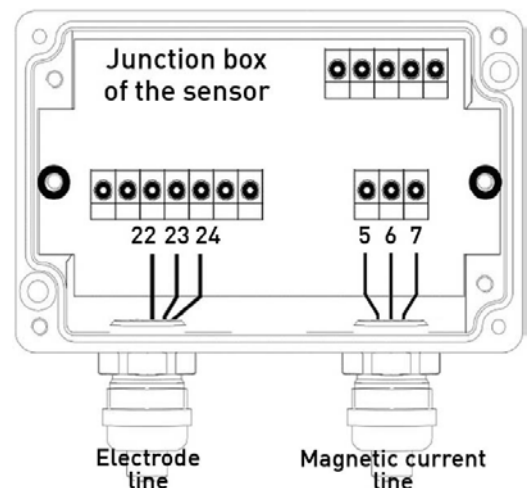
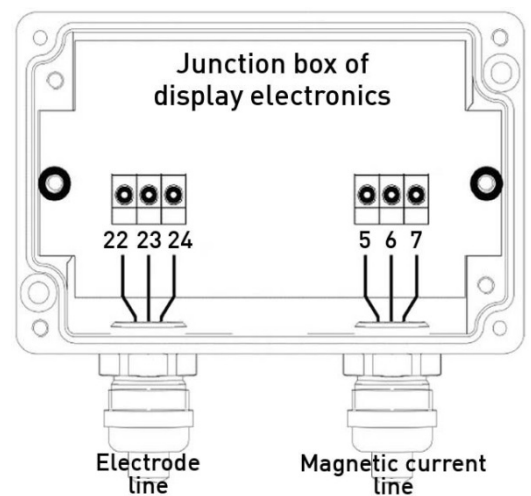

6 Commissioning

Before switching on the VMM for the first time, please observe the following instructions.

Check that

- the VMM has been installed correctly and that all screw connections are sealed.
- the electrical wiring has been connected properly.
- the measuring system is vented by flushing.

Startup conditions:

The device is not subject to specific startup conditions. However, pressure surges should be avoided.

Change the orientation of the display electronics (only compact version)

The display electronics of the compact version isn't rigidly connected to the sensor but can be turned by $\pm 180^\circ$.

The display electronics has been factory-installed so that in case of a horizontal piping and a flow direction from left to right the set orientation is in the correct position.

Follow the steps to change the orientation of the display electronics:

- ↪ Loosen the two setscrews ①.
- ↪ Turn the display electronics in the desired position.
- ↪ Tighten the two setscrews ① again.



7 Operation

The display electronics are controlled through the display and the keypad.

Display:

The display electronics has an integrated back lighted, alphanumeric display with two 16-character lines (format 10 x 50 mm). Measurement data and settings can be read directly from this display

The LCD is designed to be operated at temperatures ranging from - 20 °C to + 50 °C without being damaged.

Near freezing temperatures the display becomes slow. The readability of the measured values is reduced.

At temperatures below - 10 C°, only static values (parameter settings) can be displayed.

At temperatures exceeding 50 C°, contrast decreases substantially on the LCD and the liquid crystals can dry out.



Keys and their functions:

There are six keys for operating and changing the settings.



CAUTION! Material damage!

Do not press these keys with sharp or sharp-edged objects such as pencils or screwdrivers!

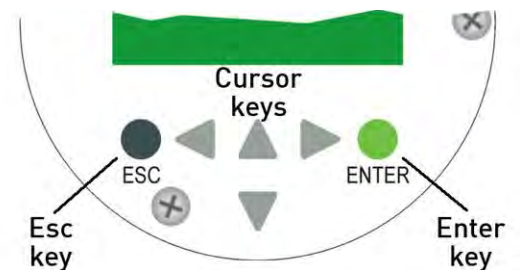

Cursor keys:



- These keys are used for
- change numerical values.
 - give YES/NO answers.
 - select parameters.

Each key is assigned a symbol as follows:

- ▶ Cursor key, right arrow; ◀ Cursor key, left arrow;
- ▲ Cursor key, up arrow; ▼ Cursor key, down arrow.

ENTER key:



The ENTER key is used for entering the parameter level from the menu level. All entries are confirmed with the ENTER key.

ESC key:



The ESC key is used to cancel the current action and leads to the next higher level. This is used for rollback. Pressing ESC key twice moves you directly to the MEASURED VALUES functional class.

Operating modes:

The display electronics of the VMM has two different operating modes:

1. Display.

In display mode, measured values can be displayed in various combinations and the same applies to the VMM settings. Parameter settings cannot be changed in this mode.

Display mode is the standard (default) operating mode when the device is switched on.

2. Programming.

The parameters of the VMM can be changed in this operating mode. After entering the corresponding password, either only the customer-modifiable functions (customer password) or all functions (service password) are released for modification.

User interface:

The user interface is hierarchically structured. At the top level you can find the Functional classes which are displayed as headings. It represents a kind of logical groups for values and parameters.

The second level is the menu level and it includes either parameters or further submenus.

The third and lowest level is the parameter level, which only includes parameters.

All functional classes are interlinked horizontally, while all sub items of a functional class are interconnected vertically.

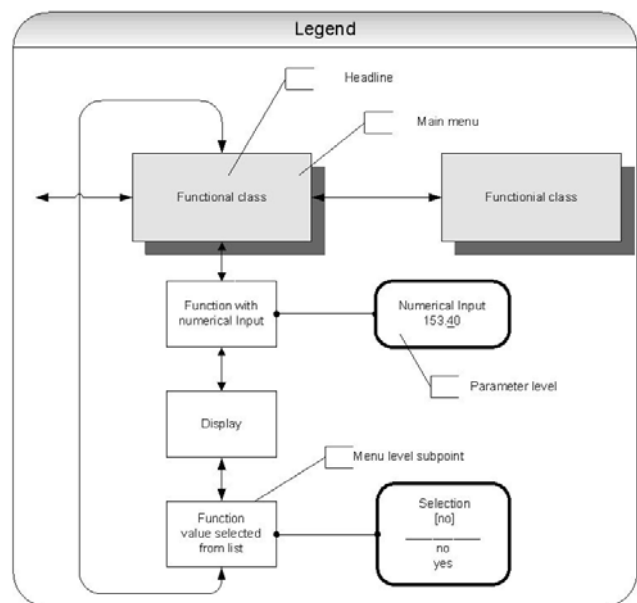

Functional classes, functions and parameters:

Functional classes are strictly written in upper case letters (headings). For the functions and parameters at the next levels upper and lower case is used.

The various functional classes and functions are described in chapter "

Functional classes (main menu)" (→ p. 24).

For the menu level always the first line of the LCD the corresponding heading for the menu item and the contents of second line is context-sensitive:

information, YES/NO answers, alternative values, numerical values (with dimensions, if applicable) or error messages.

If the user attempts to modify values for any of these parameters without entering the required password, the message "Access denied" will be displayed. See also "Operating modes" (→ p. 22) and "Passwords" (→ p. 23).

The various categories for submenu items are described below.

Selection window / make a selection:

For the selection window, the first line of the LCD always displays the heading, while the second line displays the current setting.

For the selection window, the first line of the LCD always displays the heading, while the second line displays the current setting. This setting is shown in square brackets if the system is in programming mode (→ "Operating modes", p. 22).

Function name
[selection]

In Programming mode, i.e. after a password has been entered the operator can navigate to the desired setting by using the ▲ key or the ▼ key. The actual selection will be confirmed by pressing ENTER key.

Pressing the ESC key will discard changes.

Input window / modify a value:

For the input window, the first line of the LCD always shows the heading, while the second line shows the current setting.

Modifications can only be made in Programming mode (→ "Operating modes", p. 22).

To move the flashing cursor from one decimal place to another, use the ◀ or ▶ keys.

Function name
-4.567 Unit

To in-/decrease the value of the decimal place, which is highlighted, by 1, use the ▲ or ▼ key.

To change the minus and plus sign, place the cursor in front of the first digit. To confirm and apply the change, press the ENTER key.

To discard the changes, press Esc

Passwords:

Programming mode is password protected. Entering the customer password will allow all changes that are permissible for customers.

This password can be changed when the device is first put into operation. Therefore changes should be kept in a safe place.

The factory setting for the VMM customer password is: "0002".

The service password allows modification of all functions and parameters. This password is not given to customers.

7.1 Functional classes (main menu)

The software functions of the VMM are divided into functional classes. They are arrayed in a circle and can be navigated by using the ◀ or ▶ cursor keys. To go back to your starting point (the MEASURED VALUES functional class) press Esc.

In the following, all software functions that can be accessed using the customer password are described.

Functions that are only accessible to the vendor (service functions) are not described in this manual.

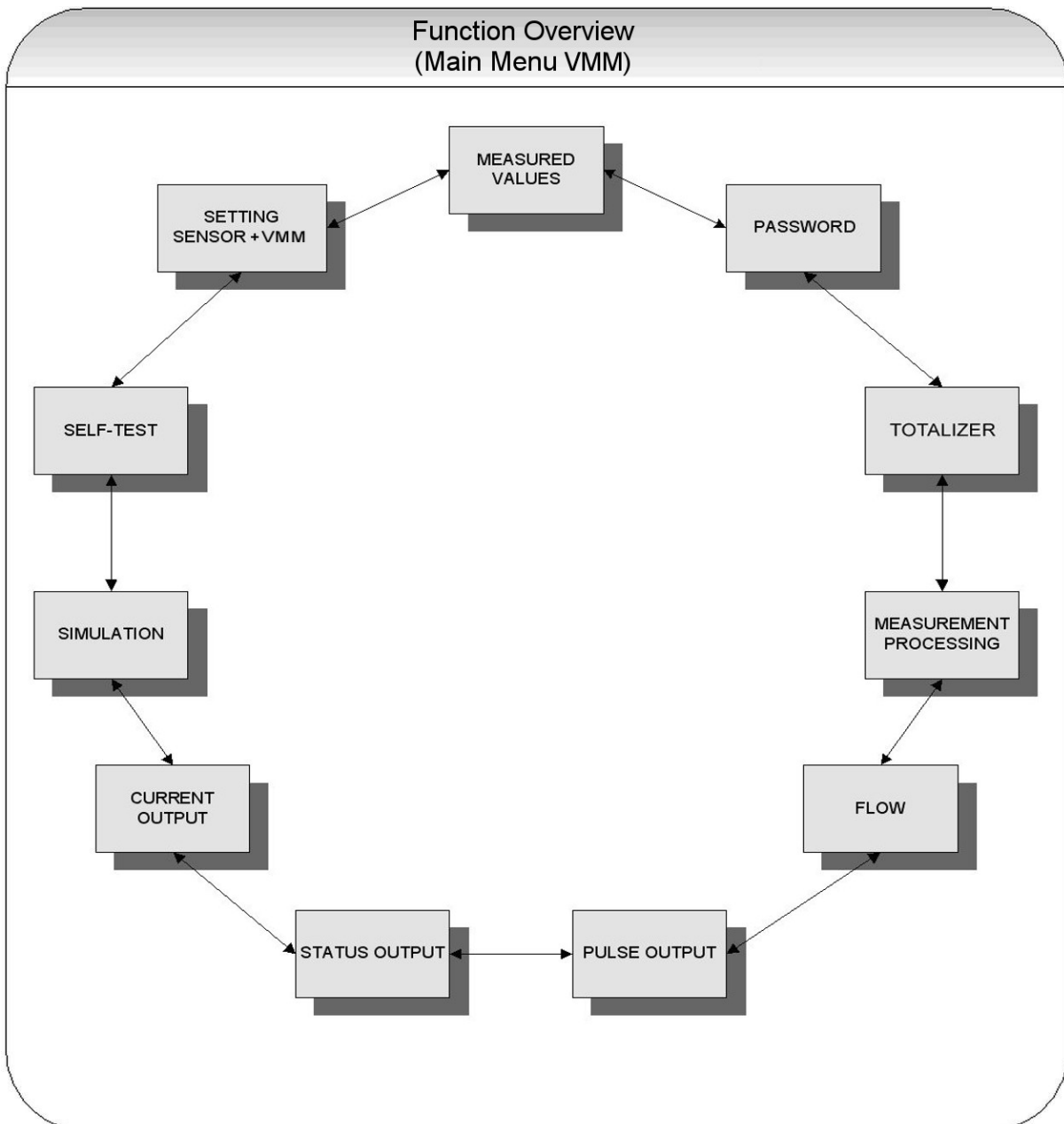

7.1.1 Measured values

The MEASURED VALUES functional class includes all functions for displaying the measured values.

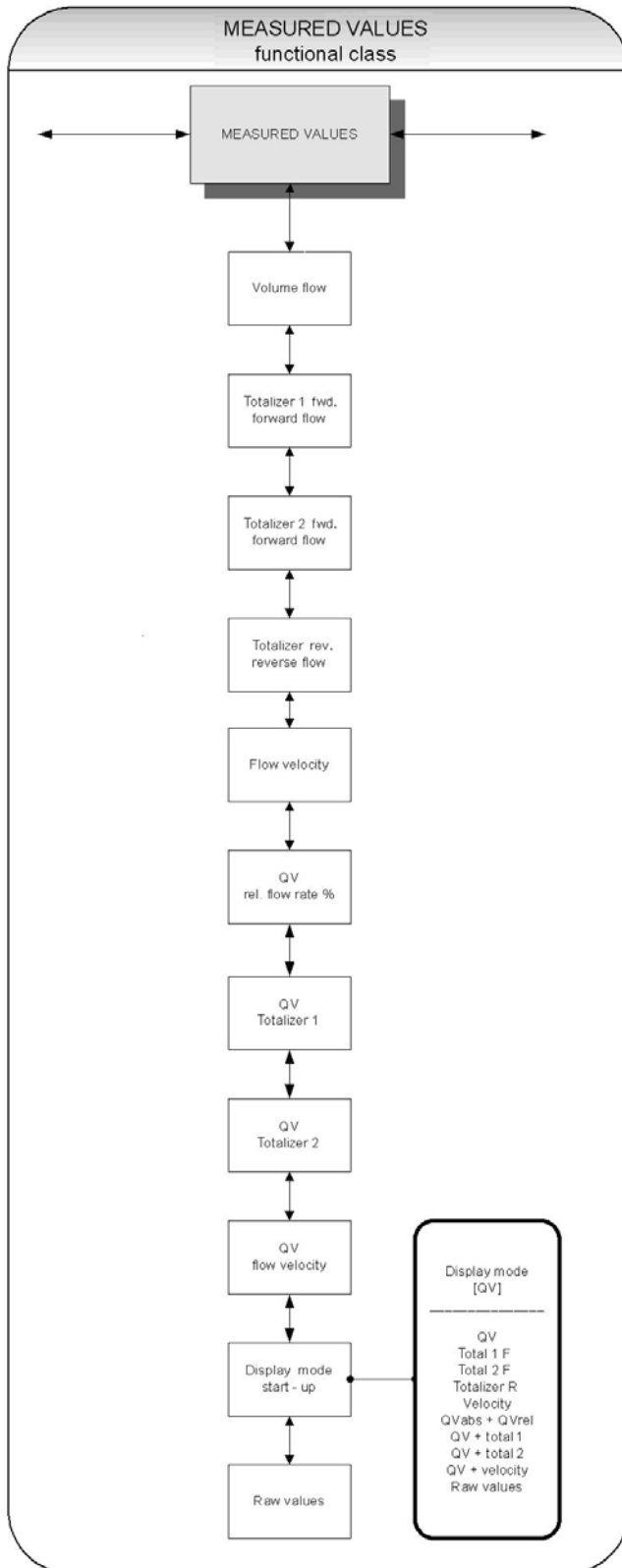

Volume flow rate:

If you select the function *volume flow* the current value for the volume flow will be displayed.

Example:

Volume flow.
100.0 m3/h

The displayed unit is defined in the functional class FLOW using the function *volume flow unit*.

Totalizer forward 1:

Totalizer forward 1 and totalizer forward 2 are independent totalizers that can also be reset separately.

With totalizer 1, for example, you can measure the yearly or monthly volume.

If you select the function *totalizer forward 1*, the current value of the totalizer forward 1 will be displayed.

Example:

Totalizer 1 fwd.
+000001.0 m3

The displayed unit is defined in the functional class TOTALIZER using the function *totalizer unit*.

Totalizer forward 2:

The function is identical with totalizer 1. For example, totalizer 2 can be used as a daily counter.

If you select the function *totalizer forward 2*, the current value of the totalizer forward 2 will be displayed.

Example:

Totalizer 2 fwd.
+000001.0 m3

The displayed unit is defined in the functional class TOTALIZER using the function *totalizer unit*.

Totalizer reverse:

If you select the function *totalizer reverse*, the current value of the totalizer reverse will be displayed.

Example:

```
Totalizer rev.
000000.0 m3
```

The displayed unit is defined in the functional class TOTALIZER using the function *totalizer unit*.

Flow velocity:

If you select the function *flow velocity* the LCD shows the current value of the average flow velocity of the medium.

Example:

```
flow velocity
1.5 m/s
```

The displayed unit is always meters per second (m/s).

The average velocity is calculated from the measured volume flow and the cross section of the meter tube. For the calculation of the cross section, the inside diameter of the meter tube is needed.

It will be defined by the function *inside diameter* in the functional class SETTINGS SENSOR + VMM".

Relative flow rate:

The relative flow rate Q_{rel} is the percentage ratio of the (current) volume flow Q_{abs} and the upper range value of the volume flow.

The calculation of the relative flow rate is based on the following formula:

$$Q_{rel} = \frac{Q_{abs} - \text{lower range limit}}{\text{upper range limit} - \text{lower range limit}} \cdot 100\%$$

If you select the function *relative flow*, the following will be displayed.

Example:

```
Relative flow
95.3 %
```

QV + forward totalizer 1:

If the function *QV totalizer 1* is selected, in the first line the value of the forward totalizer 1 and in the second line the current value of the volume flow will be displayed.

Example:

```
XXX.X m3
T1 XXX.XX m3/h
```

The displayed unit for the volume flow is defined in the functional class FLOW using the function *volume flow unit*.

The unit of the totalizer is defined in the functional class TOTALIZER using the function *totalizer unit*.

QV + forward totalizer 2:

This function is basically similar to the function *QV totalizer 1*.

The only difference is, that in the first line the value of the forward totalizer 2 is displayed.

Example:

```
XXX.X m3
T2 XXX.XX m3/h
```

QV + flow velocity:

If the function QV+ flow velocity is selected, in the first line current value of the volume flow and in the second line the current flow velocity will be displayed.

Example:

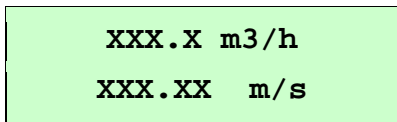

The displayed volume flow unit is defined in the functional class FLOW using the function *volume flow unit*, the unit of the flow velocity is always m/s.

Display mode during startup:

By choosing the function *display mode during startup* the operator can define the default display. This selected parameter will be displayed after switching on the device and when no keystroke occurs for a long period of time.

Example:

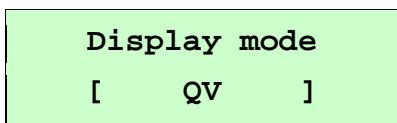

One of the following default parameters can be selected:

- QV (volume flow rate),
- totalizer 1 forward flow,
- totalizer 2 forward flow,
- totalizer R(reverse flow),
- velocity,
- QVabs + QVrel,
- QV + totalizer 1,
- QV + totalizer 2,
- QV + velocity,
- raw values.

How to change the parameter please refer to Section "Selection window / make a selection".

Raw value display:

The raw value display supports fault diagnostics and trouble shooting. Please inform our service department about the clear text error messages and content of the raw value display.

Example:

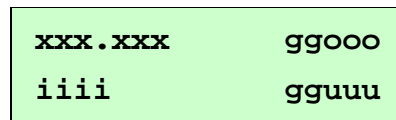

The displayed values are decimals and have the following meaning:

- xxx.xxx: Is a numeric value for the measured electrode voltage.
- iiii: Is a numeric value for the current to generate the field coil's magnetic field.
- ggooo: Is a numeric value for the upper value of the reference calibration.
- gguuu: Is a numeric value for the lower value of the reference calibration.

7.1.2 Password

The PASSWORD functional class includes the functions for entering and changing the customer password and entering the service password.

To discard the changes, press Esc.

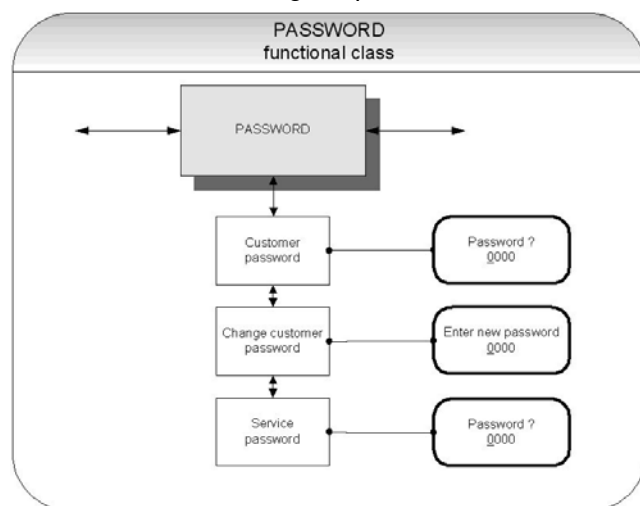

Customer password:

The customer password is intended to prevent changes for software parameters of the VMM by the control unit without permission.

If the operator does not enter a valid password, all settings can be displayed but not changed.

For selecting the desired function please use the key ▲ and ▼.

After selecting the function Change customer password and pressing ENTER key, the operator enters the parameter level for changing the customer password.

The following will be displayed:

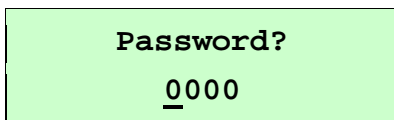

The password can be changed according to the description in section "Input window / modify a value".

After entering a valid password, the following message will be displayed:

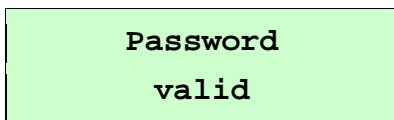

If the entered password is not correct, the following message will be displayed:

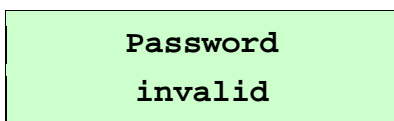

A valid customer password allows changes for all software parameters that are permissible for customers.

After the operator switched off the device or no keystroke occurs for about 15 minutes, the authorization for changes are cancelled and the password must be entered again.

Change customer password:

After entering a valid customer password, you may change the existing password and enter a new one.

The prerequisite for this is the previous, correct entry of the currently valid customer password.

For selecting the desired function please use the key ▲ and ▼.

After selecting the function *Change customer password* and pressing ENTER key, the operator enters the parameter level for changing the customer password.

The following will be displayed:

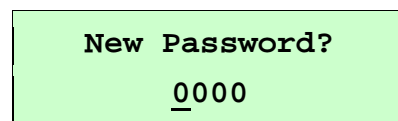

According to the description in Section "Input window / modify a value" the changes can be done.

Press ENTER key to confirm and save the new password.

Notice



A copy of the password should be kept in a safe place. Reactivation of a display electronics at the vendor's site due to a lost password is not part of our warranty!



Notice

The factory set for the customer password is **0002**.

Service password:

The service password is not required for parameter settings which are relevant for operation.

The service password is reserved for service technicians and not provided to customers.

7.1.3 Totalizer

The TOTALIZER functional class includes the following functions:

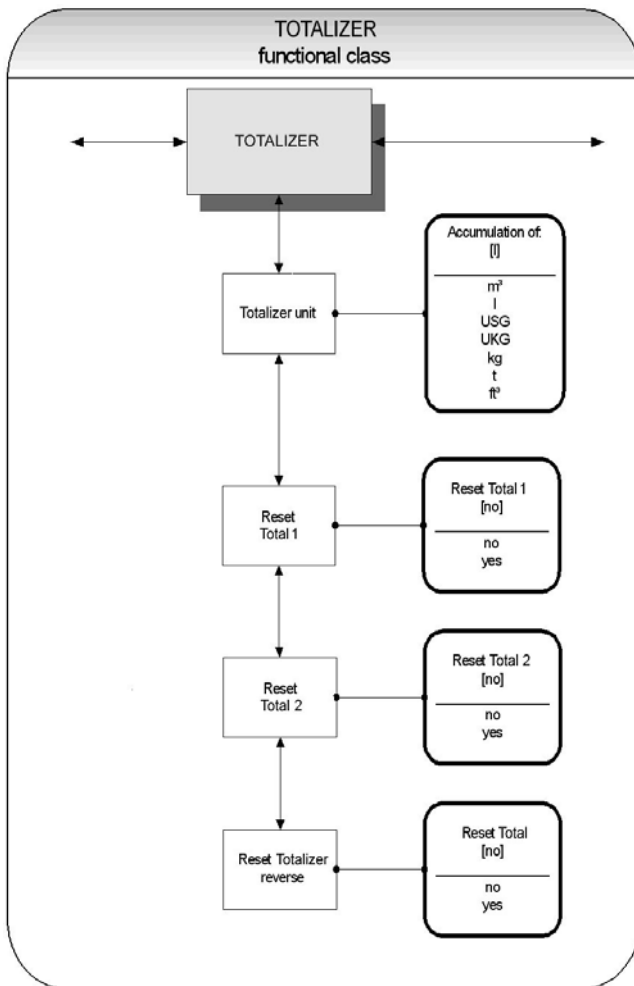

For changing the current settings and parameters the customer password is needed. Otherwise, the settings only can be watched but not be changed.

The ESC key is used for discarding changes.

Totalizer unit:

For selecting the desired function please use the key ▲ or ▼.

After choosing the function *Totalizer unit* and pressing ENTER key, the current forward and reverse totalizer unit will be displayed.

Example:

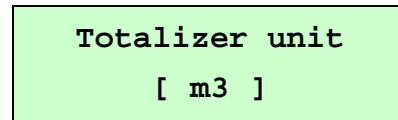

How to change the parameter please refer to Section "Selection window / make a selection".

The following units are available:

Volume units	m3	Cubic metre
	l	Litre
	USG	Gallon (US)
	UKG	Gallon (brit.)
	ft3	Cubic feet
Mass units*	kg	Kilogram
	t	Tonne

* When selecting a mass unit the liquid density is certainly required (→ "Flow", p. 31).

The changes will be confirmed by pressing the ENTER key and the new unit will be active as well for the forward totalizers and the reverse totalizers.



Notice

When the unit is changed, the totalizers will be reset to 0.00 automatically!

Totalizer reset:

The display electronics of the VMM has three independent totalizers.

Totalizer 1 and Totalizer 2 for the forward flow and a totalizer for reverse flow.

Each of them can be reset individually to the initial value 0.00.

In the first step the required totalizer has to be chosen by using the ▲ or ▼ key.

After the confirmation with the ENTER key, the function *Reset totalizer* must be selected and the following will be displayed:

Reset total?
[yes]

To reset one of the totalizers, you need to toggle to [yes] explicitly (→ "Selection window / make a selection", p. 23).

By pressing Esc or toggling to [no] the current action will be aborted without changing the totalizer.

7.1.4 Measurement processing

The MEASUREMENT PROCESSING functional class includes all functions that affect the processing of the measured values.

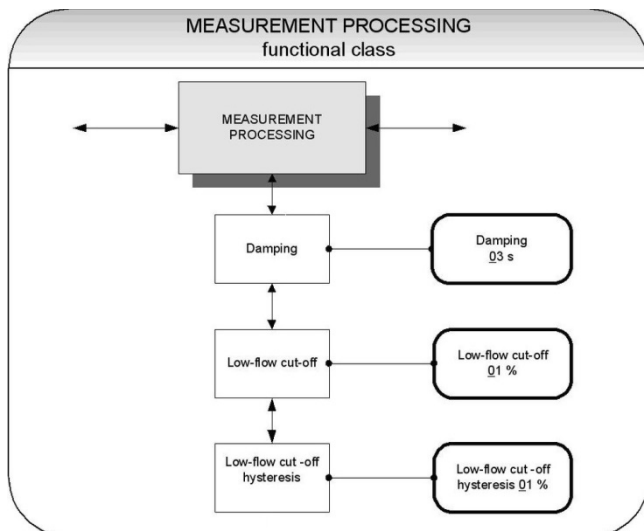

Before changing the current settings, the customer password has to be entered.

Otherwise, the settings only can be watched but not changed.

The ESC key is used for discarding changes.

Damping value:

The damping value τ is intended to attenuate abrupt changes of the flow rate or disturbances.

It affects as well the display of the measured value as the current output and pulse output of the VMM.

For selecting the desired function within a functional class please use the key ▲ and ▼.

By choosing the function *Damping value* and pressing Enter, the parameter level is entered and the current value for the damping is displayed:

Example:

Damping
03 s

The damping value can be varied within an interval from 1 to 60s (→ "Input window / modify a value", p. 23).

Notice



After a jump in the measuring variable the output measured value reaches about 99% of the new set point after 5τ .

The factory setting is **3** seconds.

Low flow cut off:

The *low flow cut off* is a threshold for flow rate (percentage the upper-range value).

If the volume drops below this value, the displayed value and the current outputs will be set to "ZERO."

For selecting the desired function please use the key \blacktriangle or \blacktriangledown . After choosing the function *Low flow cut* and pressing Enter, the following selection field will be displayed.

Example:

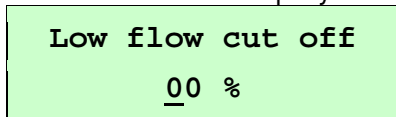

The value for low flow cut can be set from 0 to 20 % in 1-percent increments.

Hysteresis for the low flow cut-off:

The value for hysteresis for the low flow cut is given as a percentage of the upper-range value. It is the flow rate, the low flow cut has to be exceeded, to activate the display and the outputs.

For selecting the desired function please use the key \blacktriangle or \blacktriangledown . After selecting the function *Low flow cut off hysteresis* and pressing Enter, the following selection field will be displayed.

Example:

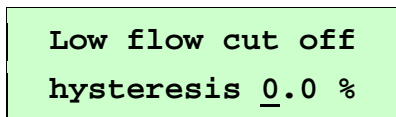

The hysteresis for the low flow cut can be set from 0 to 10 % in 1-percent increments.



Note

When the creep rate is exceeded, the analogue output is set to 0/4 mA and no pulses are output on the pulse output.

7.1.5 Flow

The FLOW functional class includes functions that affect lower- and upper-range values and the processing of the measured flow rates.

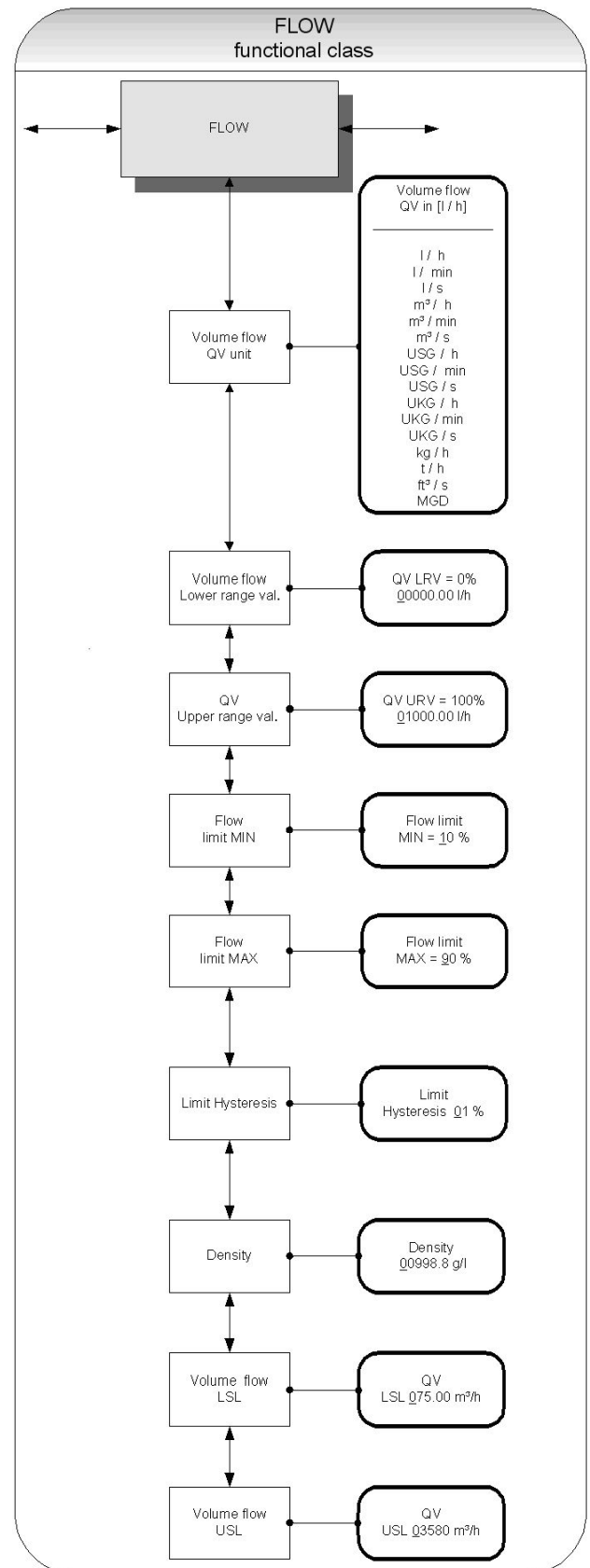

Before changing the current settings, the customer password has to be entered. Otherwise, the settings only can be watched but not changed. The ESC key is used for discarding changes.

Volume flow QV unit:

Using this function, the physical unit, limit values and the upper-range value of volume flow can be defined.

For selecting the desired function please use the key \blacktriangle or \blacktriangledown . After choosing the *Volume flow QV unit* function and pressing the ENTER key, the following selection field will be displayed.

Example:

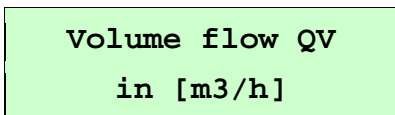

For changing the parameter please refer to the description in Section "Selection window / make a selection".

The following units are available:

Volume units:	m3 / s	m3 / min	m3 / h
	l / s	l / min	l / h
	USG / s	USG / min	USG / h
	UKG / s	UKG / min	UKG / h
	ft3 / s		
	MGD	(Mega US Gallons / day)	
Mass units*:	kg / h		
	t / h		

* When selecting a mass unit the liquid density is certainly required.

7.1.5.1 Scaling the outputs

The measuring variable volume flow rate is shown by the VMM as well as an analogue current output as a pulse output.

The correlation of output and flow rate is not fixed but it can be defined by the parameters *QV LRV* and *QV URV* (see Fig).

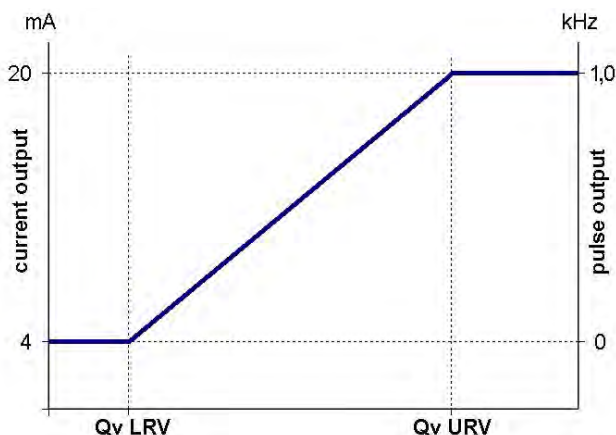

Volume flow lower-range value:

This function allows setting the lower-range value for volume flow QV LRV which corresponds to the lower-range value for the output value.

For selecting the desired function please use the key \blacktriangle or \blacktriangledown . After choosing the function *Volume flow lower-range value* and pressing Enter, the following selection field will be displayed:

Example:

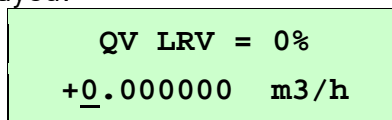

The unit for the QV LRV is defined by the function *Volume flow unit*.

Usually the value for QV LRV is set to 0.0 (factory default).

Volume flow upper-range value:

This function is intended to set the upper-range value for volume flow QV URV which corresponds to the upper-range value for the output value.

After choosing the function Volume flow upper-range value and pressing the ENTER key, the following selection field will be displayed.

Example:

```

QV URV = 100%
+01000.00 m3/h
    
```

The unit for the QV URV is defined by the function *Volume flow unit*.

7.1.5.2 Limit value messages

Fig: Limit value message and hysteresis.

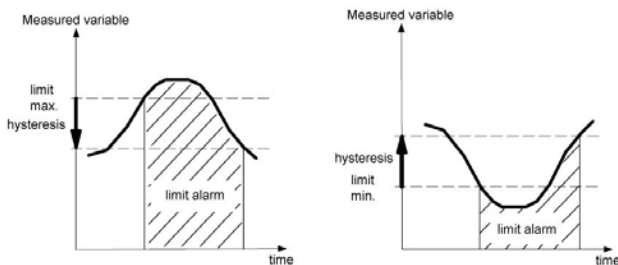

Volume flow limit MIN:

The MIN limit value for volume flow can be shown by the status output.

The value for volume flow limit MIN is a percentage of the current measuring range (lower-range value QV LRV to upper-range value QV URV). If the volume flow falls below that limit, the status output will be set and the current output will change to alarm value, if the alarm functions have been enabled (see Fig above).

For selecting the desired function please use the key \blacktriangle or \blacktriangledown . After choosing the function *Volume flow limit MIN* and pressing Enter, the following selection field will be displayed.

Example:

```

Flow limit
MIN = 10 %
    
```

The value can be set in 1-percent increments.

Volume flow limit MAX:

The MAX limit value for volume flow can be shown by the status output.

The value for volume flow limit MAX is a percentage of the current upper-range value QV URV. If the volume flow surpasses this limit, the status output will be set and the current output will change to alarm value, if the alarm functions have been enabled (see Fig above).

For selecting the desired function please use the key \blacktriangle or \blacktriangledown . After choosing the function *Volume flow limit MAX* and pressing Enter, the following selection field will be displayed:

Example:

```

Flow limit
MAX = 90 %
    
```

The value can be set in 1-percent increments.

QV limit hysteresis:

The value for Qv limit hysteresis is a percentage of the current upper-range value QV URV. It specifies the difference between the flow rate and the set volume flow limits which is needed to reactivate respectively deactivate the limit alarm.

For selecting the desired function please use the key \blacktriangle or \blacktriangledown . After choosing the function QV limit hysteresis and pressing the ENTER key, the following selection field will be displayed.

Example

```

Limit
hysteresis 00 %
    
```

The value can be set in 1-percent increments from 0 to 10 %.

Density:

If a mass unit in kg or t is used as flow unit, the density of the medium must be entered in [g/l]. The mass flow will be calculated from the volume flow measurement using the density.

After choosing the function *Density* and pressing Enter, the current density value will be displayed:

Example:

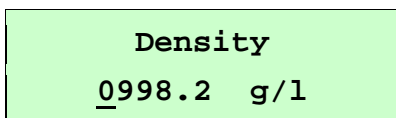

The density can be entered precise to 0.1 g/l.



Notice

The density is not measured. It is a parameter.

Volume flow LSL (read only):

This value represents the minimum lower range value based on the inside diameter of the sensor. This value is normally set for a flow velocity of 0.25 m/s.

Example:

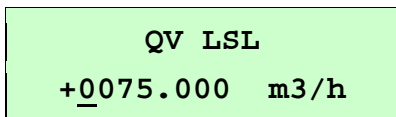

Volume flow USL (information field):

This value represents the maximum upper range value based on the inside diameter of the sensor. This value is normally set for a flow velocity of 11 m/s.

Example:

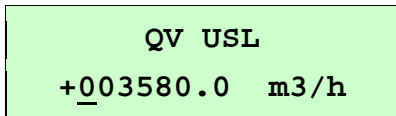

7.1.6 Pulse output

The PULSE OUTPUT functional class includes the functions regarding the pulse output.

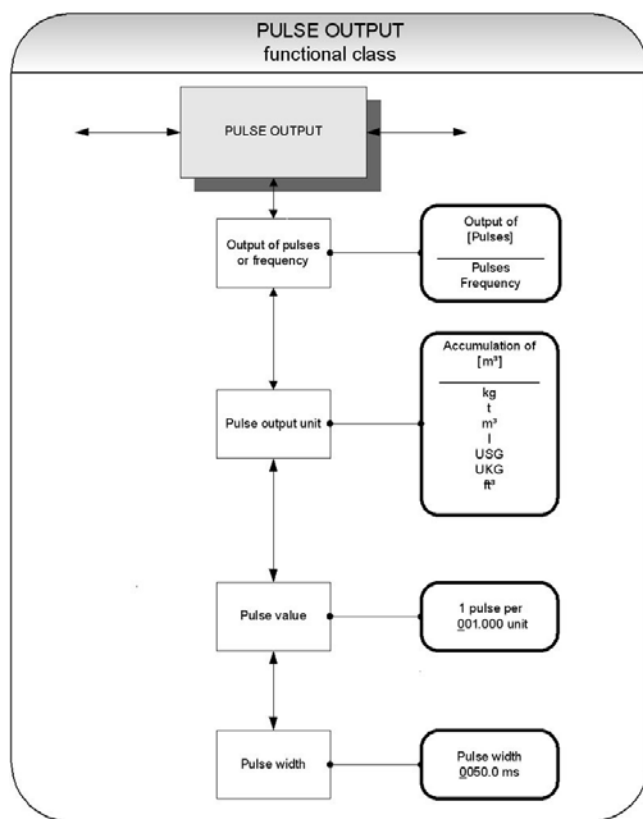

The function *Pulse or frequency output* is used to define the mode for the digital output – either pulses per flow unit or a frequency 0 to 1 kHz corresponding to the measuring range.

7.1.6.1 Frequency output

When selecting "frequency", the maximum frequency of 1 kHz will be output when the upper-range value for mass or volume flow QV URV is reached (depending on the selected pulse unit). If the flow rate falls below the volume flow limit MIN, the frequency is set to 0 Hz.

7.1.6.2 Pulse output

When selecting "pulses", pulses per flow unit will be output by the transmitter. The pulse shape is defined by the parameters pulse output unit, pulse value and pulse width.

When choosing an improper combination of these parameters (e.g. the number of pulses per time unit cannot be generated due to the pulse width which is too large), one of the following error messages will be displayed.:

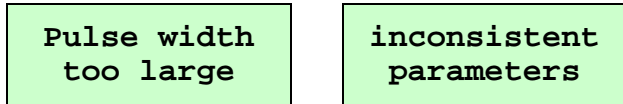

For selecting the desired function please use the key \blacktriangle or \blacktriangledown . After choosing the function *output of pulses* or *frequency* and pressing Enter, the following selection field will be displayed.

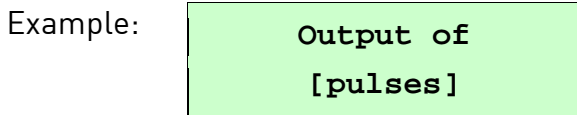

Pulse output unit:

This function is used to define the unit to be accumulated.

After selecting the function Pulse output unit, press Enter to enter the parameter level. The following selection field will be displayed:

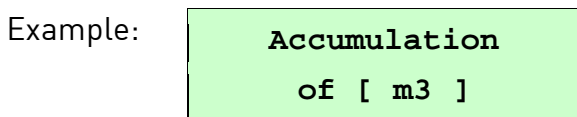

For this parameter the following units are available:

Volume units:	m3	Cubic metre
	l	Litre
	USG	Gallon (US)
	UKG	Gallon (brit.)
	ft3	Cubic feet
Mass units:	kg	Kilogram
	t	Tonne

Pulse value:

This function is used to define how many pulses will be output per accumulated unit. After selecting the function *Pulse value*, press the ENTER key to display the current unit:

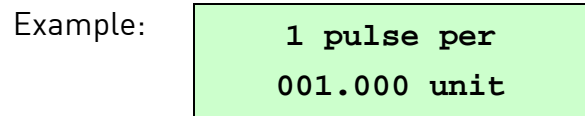

Pulse width:

This function is intended to change the width of the pulses. For selecting the desired function please use the key \blacktriangle or \blacktriangledown . After selecting the function Pulse width, press Enter to display the actual setting for this parameter:

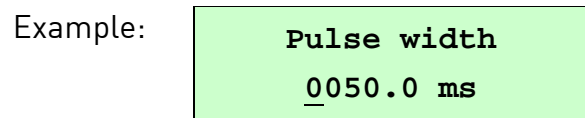

If the pulse width for the actual pulse number is selected too high, the warning message "Value too high" appears and the changes are not applied.

The maximum output frequency f can be calculated by

$$f = \frac{1}{2 \cdot \text{pulse width [ms]}} \leq 1000\text{Hz}$$



Notice

For connection of electronic counters, we recommend a pulse width greater than 4 ms; for electromechanical counters the value should be 50 ms.

7.1.7 Status output

The functional class STATUS OUTPUT includes the functions for setting the status output.

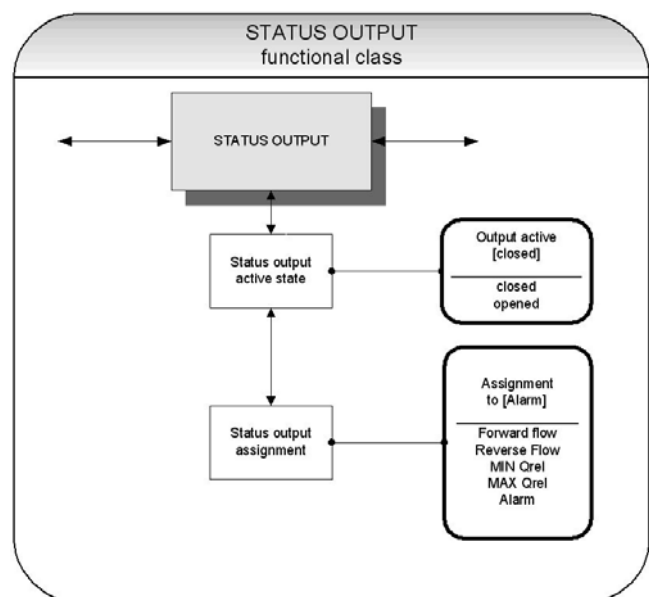

Status output active state:

The function *Status output active state* is intended to define the behaviour of the status output.

The status output is comparable to an electrical relay that can be configured as make or break contact.

For safety-relevant applications, the setting break contact is highly recommended so that a power failure or failure of the electronics can be detected as an alarm.

In standard applications, the setting make contact is usually used.

For selecting the desired function please use the key ▲ or ▼. After selecting the function *Status output state active state*, press the ENTER key to display the current setting:

Example:

**Output active
[closed]**

As mentioned in "Selection window / make a selection", one of the following settings can be chosen.

Setting	Function
closed	Status output operates like <u>break contact</u>
opened	Status output operates like <u>make contact</u>

Status output assignment:

This function allows the operator to define the event assignment for the status output.

For selecting the desired function within the class please use the keys ▲ and ▼. After selecting the function Status output assignment, press Enter, the current setting will be displayed:

Example:

**Assignment
to [Reverse flow]**

As mentioned in Section "Selection window / make a selection" one of the following settings can be chosen:

Detection of flow direction:	Forward flow Reverse flow
Limit values:	MIN Qrel MAX Qrel
All limit values and error detection:	Alarm

The default setting is *reverse flow*.

7.1.8 Current output

The CURRENT OUTPUT functional class includes the settings for the current outputs of the display electronics.

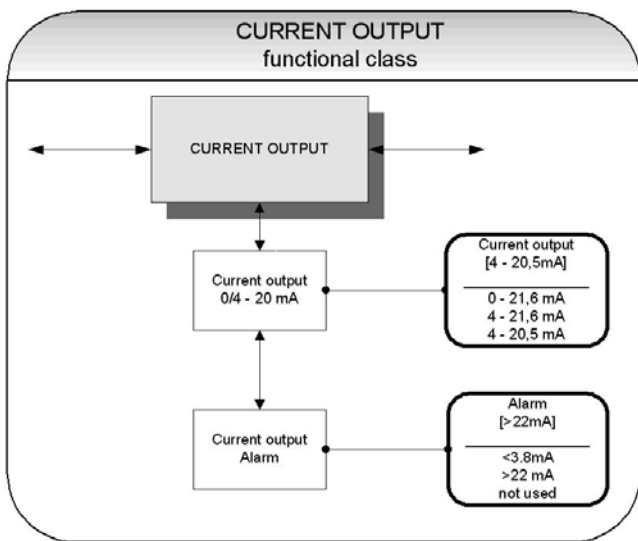

The current output is generally assigned to volume flow.

Current output 0/4 - 20 mA:

This function is intended for defining the operating range for the current output.

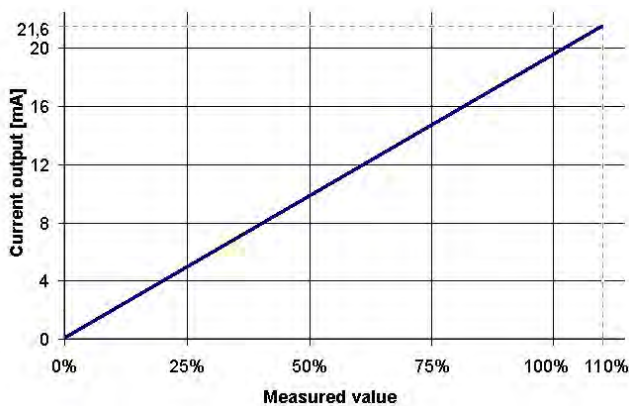

The standard range from 4 to 21.6 mA uses the measuring range up to 110 %.

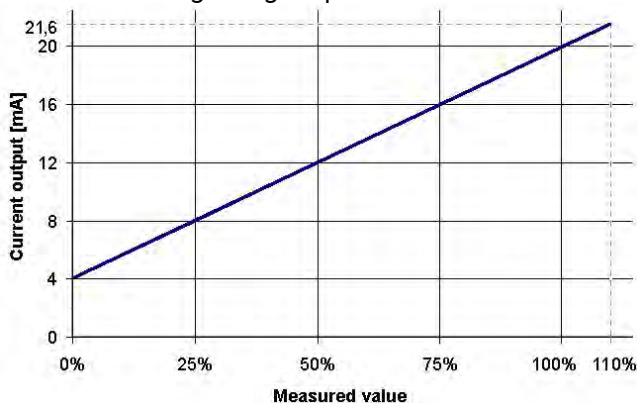

The range from 4 to 20,5 mA is according to the NAMUR-recommendation and uses the measuring range up to 104%.

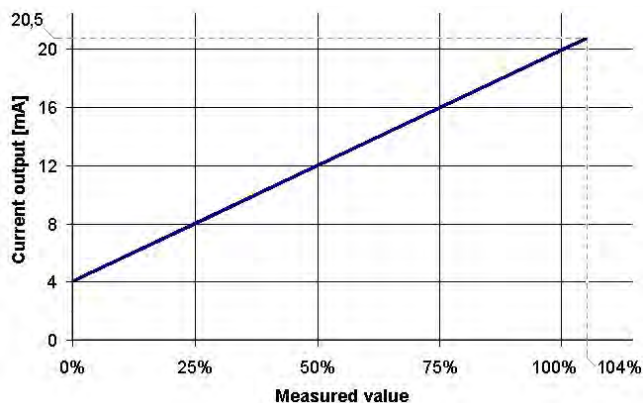

For selecting the desired function within the class please use the keys ▲ and ▼.

After selecting the function *Current output 0/4 - 20 mA*, press the ENTER key to display the current setting:

Example: **Current output [4-21.6] mA**

One of the following settings can be chosen (→ "Selection window / make a selection", p. 23):

- 0 - 21.6 mA
- 4 - 21.6 mA
- 4 - 20.5 mA

Current output alarm:

This function is intended for defining the state for the current output when an alarm state occurs. This information can be analyzed in the process management system.

For selecting the desired function within the class please use the keys ▲ and ▼.

After selecting the function *Current output alarm*, press the ENTER key to display the current setting:

Example: **Alarm [>22 mA]**

One of the following settings can be chosen (→ "Selection window / make a selection", p. 23):

Setting	Function
not used	no alarm function
>22 mA	rise of current in case of alarm
<3.8 mA	reduction of current in case of alarm

7.1.9 Simulation

The functional class SIMULATION includes the functions for simulating output signals or output states.

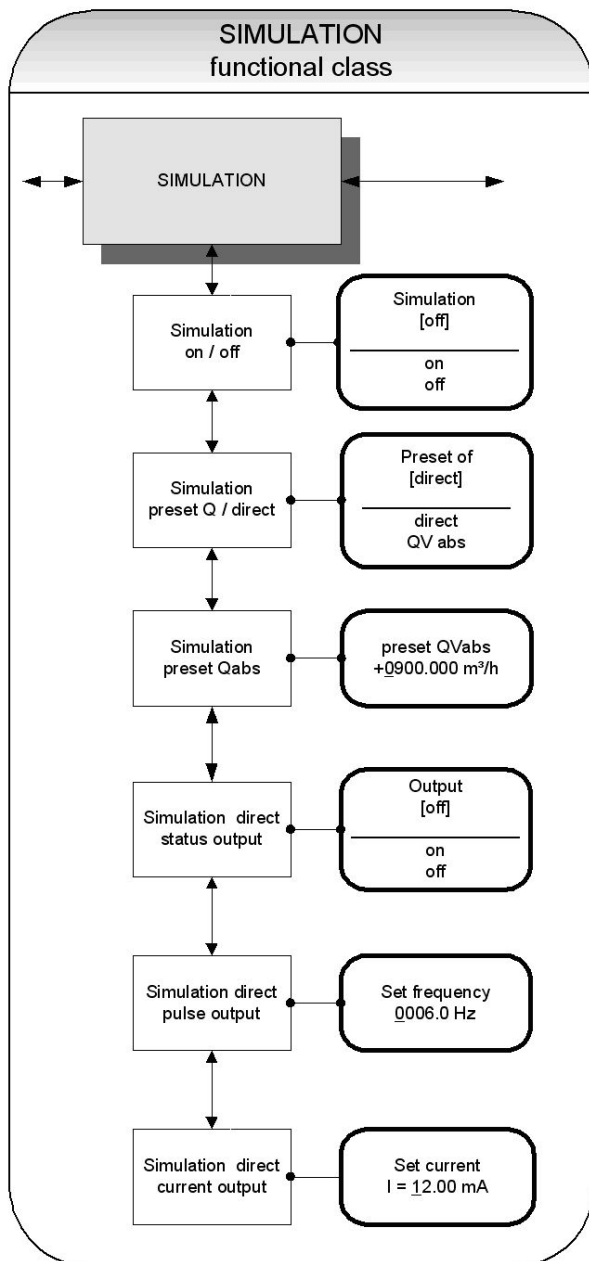

If simulation mode is activated, all output signals will be generated depending on the selected items. This function enables testing of peripherals connected to the device without water flow.

Simulation on / off:

The function *Simulation on/off* is intended for activating or deactivating simulation mode

For selecting the desired function within the class please use the keys ▲ and ▼.

After selecting the function *simulation on/off*, press the ENTER key to display the current setting:

Example:

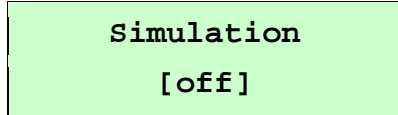

For changing the parameter please refer to the description in Section "Selection window / make a selection".

Notice



Simulation will be deactivated automatically after restarting the device or without a keystroke for at least 10 minutes.

Simulation preset value Q / direct:

This function is intended for defining whether a volume flow rate is preset or the outputs will be set directly.

For selecting the desired function within the class please use the keys ▲ and ▼.

Press ENTER key to display the current selection for the type of simulation:

Example:

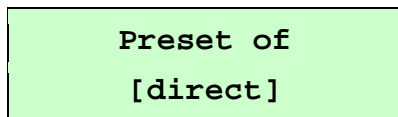

One of the following settings can be chosen (→ "Selection window / make a selection", p. 23):

Setting	Function
direct	<p>Status-, pulse-, und current output* will be set directly</p> <p>* It is useful to make the presets for the outputs before starting simulation mode, using menu items <i>Simulation status output</i>, <i>Simulation pulse output</i> and <i>Simulation current output</i>.</p> <p>In this manner the settings can be modified specifically.</p> <p>All outputs will be simulated simultaneously!</p>
QVabs	The measuring variable will be set

Simulation preset Q*:

Using this function a „measuring variable“ is preset for simulating a flow rate. Flow rates for both directions will be supported. The outputs will be affected by the simulated value for the measured value indirectly.

For selecting the desired function within the class please use the keys ▲ and ▼.

After selecting the function *Simulation preset Q*, press the ENTER key to enter the parameter level for putting in the requested value:

Example:

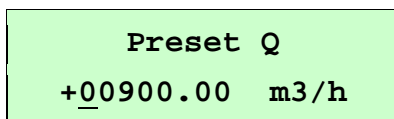

The simulation value is entered as described in Section "Input window / modify a value".

* This parameter *Preset Q* is of relevance only, if the parameter *Simulation preset Q / direct* is set to "QVabs".

Direct simulation – status output *:

Using the function *Simulation direct status output* the status output can be affected directly.

For selecting the desired function within the class please use the key ▲ or ▼.

After selecting the function *Simulation direct status output*, press the ENTER key. The current setting will be displayed:

Example:

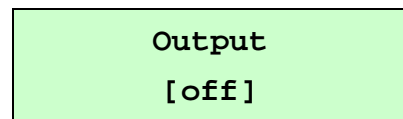

For changing the parameter please refer to the description in Section "Selection window / make a selection".

* This parameter is of relevance only, if the parameter *preset of* is set to „direct“.

Direct simulation – pulse output *:

Using the function *Simulation direct pulse output* the requested frequency for the pulse output can be defined.

For selecting the desired function within the class please use the key ▲ or ▼.

After selecting the function *Simulation direct pulse output*, press the ENTER key. The current value for the frequency will be displayed:

Example:

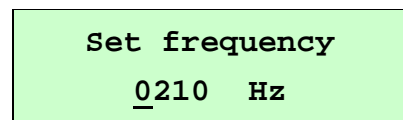

The frequency can be set within bounds of 6 Hz to 1100 Hz

For changing the parameter please refer to the description in Section "Input window / modify a value".

* This parameter is of relevance only, if the parameter *preset of* is set to „direct“.

Direct simulation – current output *:

Using this function the requested value for the current output can be defined.

For selecting the desired function within the class please use the key ▲ or ▼.

After selecting the function *Simulation direct current output*, press the ENTER key. The actual value for the current will be displayed:

Example:

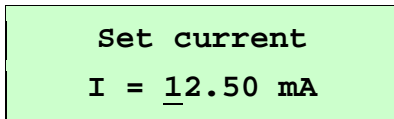

The current can be set within bounds of 0 to 23 mA. For changing the parameter please refer to the description in Section "Input window / modify a value".

* This parameter is of relevance only, if the parameter *preset of* is set to „direct“.

7.1.10 Self-test

The function class SELF-TEST includes all functions relating to the self-test of the sensor. The diagnostic functions of the display electronics, which monitor the signals of the sensor and proper functioning of the electronics and the software, are always active and cannot be switched off.

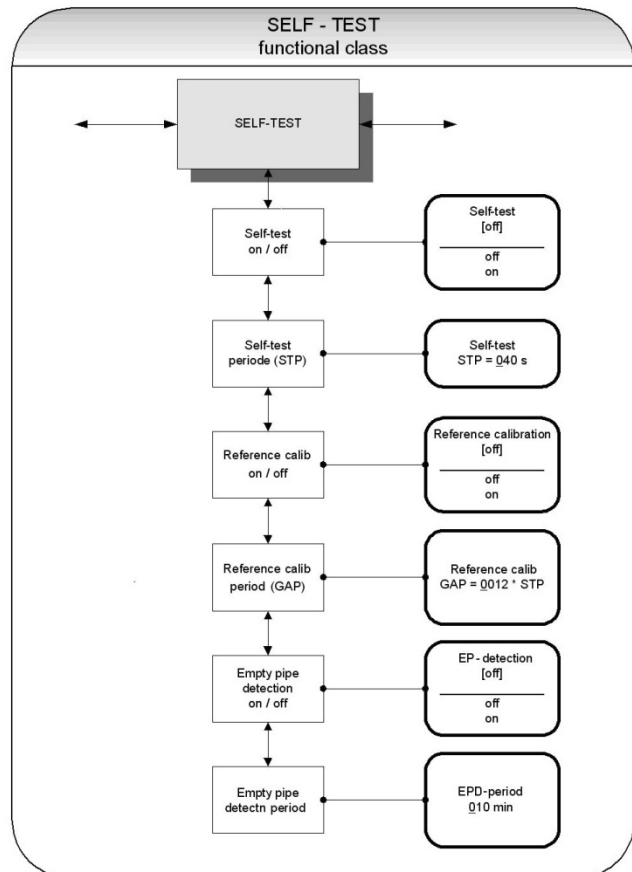

Self-test on / off:

The *Self-test on/off* function is intended for enabling or disabling the monitoring function of the field coil current. This function is useful for suppressing temperature dependencies of the display electronics.

After selecting the function *Self-test on/off* using the key ▲ or ▼ press the ENTER key. The current setting will be displayed.

Example:

Self-test
[off]

The default setting for the monitoring function for the field coil current is „on“.

For changing the parameter please refer to the description in Section "Selection window / make a selection".

Notice



During the sampling time for the field coil current of 0,5 seconds, the transmitter is offline. The last measured value will be shown at the signal outputs.

Self-test period (STP)*:

Using this function the time gap for the periodical measurement of the field coil current is defined.

The time gaps can be set within bounds of **35 to 999 s**.

After selecting the function Self-test period (STP) using the key ▲ or ▼, press the ENTER key for entering the parameter level. The current setting for the STP will be displayed:

Example:

Self-test
STP = 040 s

For changing the parameter please refer to the description in Section "Input window / modify a value".

* The parameter *Self-test period (STP)* is of relevance only, if the parameter *Self-test* is set to „on“.

Reference calibration on / off:

The function *Reference calibration on/off* is used to enable or disable the periodical recalibration of the transmitter. This function is useful for periodical self-monitoring and for maintaining the long-term stability of the display electronics.

After choosing the function *Reference calibration on/off* by the use of key ▲ or ▼ and pressing Enter, the following selection field will be displayed:

Example:

Reference calib.
[off]

For changing the parameter please refer to the description in Section "Selection window / make a selection".

Reference calibration period (GAP):

This function *Reference calibration period* is used to define after how many STPs the reference calibration will be performed.

Example:

The Self-Test period (STP) is set to 40 seconds. The reference calibration should be performed every 6 hours. Therefore you have to enter for the GAP:

$$GAP = \frac{6 \cdot 3600s}{40s} = 5400$$

1 hour = 3600 s

Self-Test period STP

For selecting the desired function within the class please use the key ▲ or ▼.

After selecting the function *Reference calibration period (GAP)* using the key ▲ or ▼ press the ENTER key. The current setting for this parameter will be displayed:

7.1.11 Settings Sensor

This functional class SETTINGS SENSOR + VMM includes the general settings for the device.

Example:

```
Reference calib.
GAP=05400* STP
```

For changing the parameter please refer to the description in section "Input window / modify a value".

Empty pipe detection on / off:

The function *Empty pipe detection on / off*, is used for enabling or disabling the continuous empty pipe detection.

After selecting this function by the use of key **▲** or **▼** and pressing Enter, the following selection field will be displayed:

Example:

```
EP detection
[on]
```

The default setting for this parameter is „on“.

For further information how to change the parameter please refer to the description in section "Selection window / make a selection".

Empty pipe detection period:

The function *Empty pipe detection period*, is intended for defining the period of time after which the empty pipe detection will be regularly carried.

After choosing this function using the key **▲** or **▼** and pressing Enter, the following selection field will be displayed:

Example:

```
EPD-period
10 Min
```

For changing the parameter please refer to the description in Section "Input window / modify a value".



Notice

When entering 00 Min for this parameter, the detection will be performed continuously.

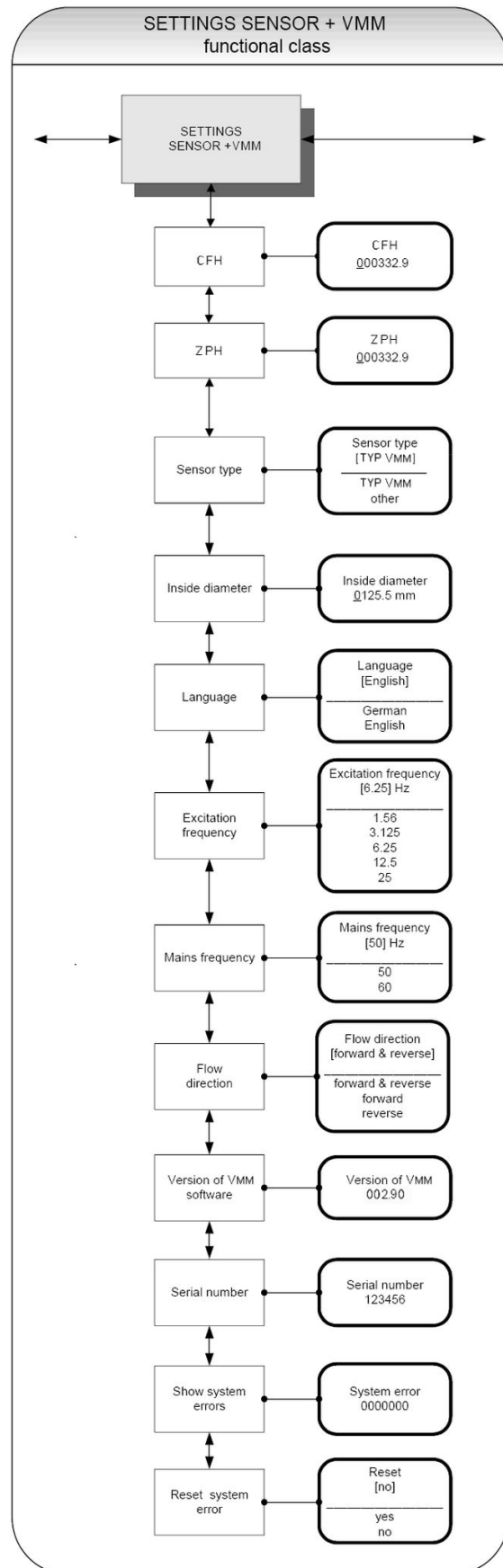

Sensor constant CFH:

The sensor constant CFH is determined by calibration and it's a characteristic value for the sensor.

The value for CFH must be entered to ensure a correct measurement. It will be found on the rating plate of the sensor.

After selecting the function *Sensor constant* function using the key ▲ or ▼ and pressing Enter, the parameter level will be entered and the actual value for sensor constant CFH will be displayed.

Example:

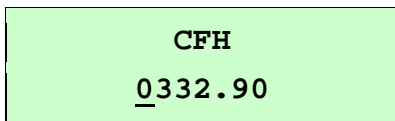

CAUTION! Measuring errors!

Changing the sensor constant CFH to a value that differs from the value on the rating plate of the sensor will result in measuring errors!

Note

The CFH value is signed. If the inlet and outlet are mixed up during installation (the flow of direction is marked on the sensor with an arrow), the display electronics displays negative measurement values in the "Supply". A positive value is displayed again by changing the sign of the CFH value.

No changes to the electrical cable connections are required.



Sensor type:

The function Sensor type is intended for defining the type of sensor which is connected to the display electronics. The distinction of the sensor type is necessary and essential because the algorithm for flow rate calculation differs from sensor type to sensor type.

After selecting this function using the key ▲ or ▼ and pressing Enter, the current setting will be displayed:

Example:

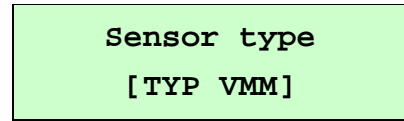

This parameter is factory-set and it has to be changed only when the transmitter is used with a different type of sensor.

Inside diameter:

The inside diameter of the connected sensor is needed for calculating the mean flow velocity. To ensure a correct measurement the diameter must be specified exactly.

After choosing the function inside diameter using the key ▲ or ▼ and pressing Enter, the following selection field will be displayed.

Example:

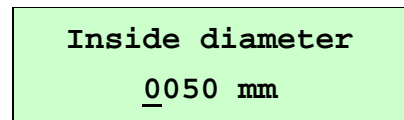

For changing the parameter please refer to the description in Section "Input window / modify a value".

Language:

English and German are available for the user guidance of the VMM.

The function *Language* is intended for setting the language.

After choosing the desired function using the key ▲ or ▼ and pressing Enter, the following selection field will be displayed:

Example:

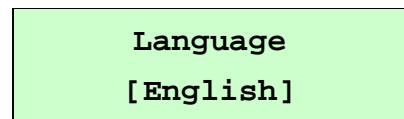

For changing the parameter please refer to the description in Section "Input window / modify a value".

Excitation frequency:

The function *Excitation frequency* is intended for setting the excitation frequency of the field coil current. Because of the inductance of the field coils the maximum frequency is limited and that's why it can't be assigned freely.

The factory-set for the excitation frequency is 6.25 Hz.

After choosing the desired function using the key \blacktriangle or \blacktriangledown and pressing Enter, the following selection field will be displayed:

Example:

Excitation freq.
[6.25Hz]

For changing the parameter please refer to the description in Section "Selection window / make a selection".

Caution! Reference calibration required!



If the excitation frequency is changed, a reference calibration (→ "Reference calibration on / off", p. 41) must be accomplished!

Otherwise the measuring accuracy is not ensured.

Mains frequency:

To provide the optimum interference suppression the mains frequency is needed and the function *Mains frequency* is intended to enter this parameter.

The default setting is 50 Hz.

After choosing the function *Mains frequency* using the key \blacktriangle or \blacktriangledown and pressing Enter, the following selection field will be displayed

Example:

Mains frequency
[50] Hz

For changing the parameter please refer to the description in Section "Selection window / make a selection".

Flow direction:

This function is intended to define the flow direction that is taken into account by the display electronics.

That way for example the setting "*forward*" will prevent reverse flow from being measured.

After selecting the function *Flow direction* using the key \blacktriangle or \blacktriangledown and pressing Enter, the current setting will be displayed.

Example:

Flow direction
[forward]

For this parameter the following settings are available:

Output signal curve at the setting

forward:

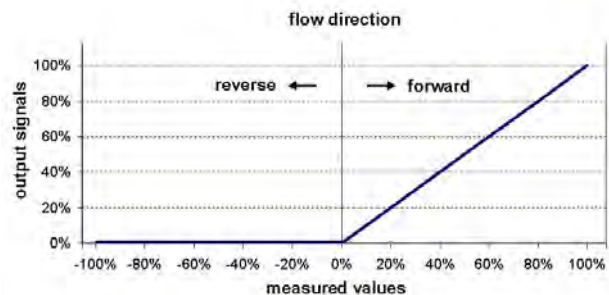

reverse:

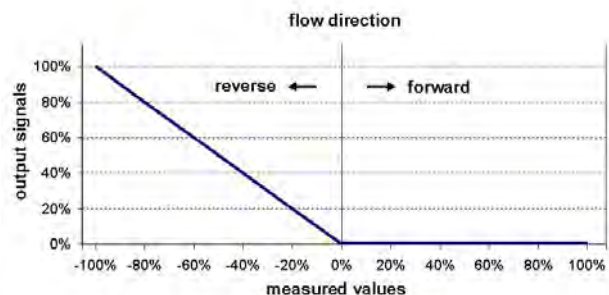

forward & reverse:

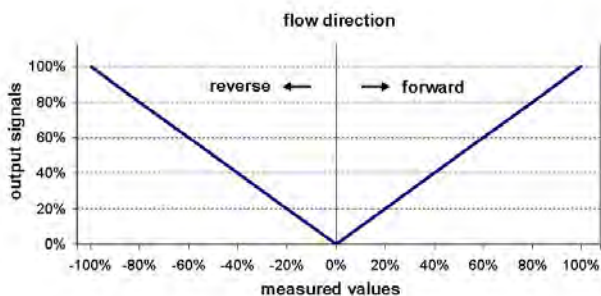

Software version (information field):

After selecting the function *Software version* the version of the VMM software will be displayed:

After choosing the desired function using the key \blacktriangle or \blacktriangledown and pressing Enter, the software version will be displayed:

Example:

```
Version of VMM
01.70
```

Serial number (information field):

The parameter *Serial number* is unique and allows a reference if the device needs servicing. The serial number is printed on the rating plate of the display electronics.

After selecting this function using the key \blacktriangle or \blacktriangledown and pressing Enter, the serial number will be displayed.

Example:

```
Serial number
0100683
```

Show system errors:

This function is intended to show the history of system errors that have occurred.

After selecting the function *show system errors* using key \blacktriangle or \blacktriangledown and pressing Enter, the code of last system error will be displayed (→ 8.1 "System errors").

Example:

```
System errors
0000000
```

Reset system error:

This function is intended to reset the system error list.

After fixing the error cause the corresponding system error can be reset. Therefore select the function *reset system error* using key \blacktriangle or \blacktriangledown and pressing Enter. The following message will be displayed:

```
Reset error
[no]
```

To reset a system error, you need to toggle to [yes] explicitly. By pressing Esc or toggling to [no] the current action will be aborted, the menu item is quitted without resetting (→ "Selection window / make a selection", p. 23).

If the message reappears shortly after, do contact our technical service department.

8 Errors and returns

Based on the meticulous manufacturing process, performance test and final inspection of the device, trouble-free operation of the VMM is expected when installed and operated in accordance with this manual. However, if it nevertheless becomes necessary to return the unit to SIKA, please follow the instructions in the following section.

WARNING! Risk of injury through toxic or hazardous substances!



Remnants of toxic or hazardous substances in the dismantled VMM can lead to damage to health or cause significant property damage.

- ☞ Purge or neutralise the unit before return shipment!
- ☞ Comply with § 8.3 "Return shipment to the manufacturer"!

CAUTION! Material damage!



The VMM cannot be repaired by the user. In case of a defect, the device must be returned to the manufacturer for repair.

- ☞ Never perform any repair on the VMM yourself.

The integrated diagnostic system of the VMM distinguishes between two types of errors: System errors (→ § 8.1) and Self-test errors (→ § 8.2).

8.1 System errors

Errors that indicate system memory failure, division by zero or a damage of the electronics unit are characterized as **system errors**. These error messages are not reset automatically when the error disappears.

If the cause of any error messages described below cannot be fixed, please contact the SIKA Service.

System errors will be displayed starting with the message "system error" followed by a 5-digit number in hexadecimal code.

The error codes are explained in the following table.

If several errors occur at the same time, the hexadecimal sum of the individual errors will be displayed. This allows an easy identification of the single error codes.

Identifier	Error code	Description
System errorExtEEProm	0x00002	External EEPROM (data memory chip DSM) plugged in but is empty, not initialized.
System errorIntEEProm	0x00004	Internal EEPROM (calibration display electronics) present but empty / not described.
System errorEEPROM	0x00010	Failure when saving or reading of memory data.

8.2 Self-test errors

Self-test errors such as problems with a sensor line or inconsistent parameter settings are displayed as textual error messages on the LCD. When the cause of error has been fixed, the message disappears from the display automatically.

When a self-test error occurs the corresponding error message is displayed as plain text in the second line of the LCD.

The language is set by parameter language (→ Parameter "Language" in § 7.1.11) to English (standard) or German.

The following table details what problems you can solve yourself and how to solve them.

Problem (indication on the display)	Possible cause	Troubleshooting
Empty pipe	Empty-pipe detection has been activated, pipe is empty	Filling must be ensured
Exciter current	Interruption / short circuit in the excitation coil. All signal outputs will be set to zero.	Check the wiring between field coil and display electronics.
Measuring circuit saturated	The measured electrode voltage is too high. All signal outputs will be set to zero.	Flow rate exceeds the upper range value. Vmax > 10 m/s.
Current saturated	The current output is overloaded. Based on the selected settings and the current assigned measured variable, the output current is > 20.4 mA.	Flow rate exceeds the upper range value. Vmax > 10 m/s. Check the upper-range value and the flow rate settings.
Pulse output saturated	The current measured value requires a pulse rate, which can not be generated with the set pulse duration and pulse value.	Check pulse duration, pulse value, and measuring range. Check the flow rate.
Parameter inconsistent	The set parameters are contradictory. Example: The combination of Upper-range value, pulse value and pulse duration has to fit for all measured values.	Check the parameter settings.
Missing EEPROM	The data memory module (DSM) with the calibration data of the sensor and the customer-specific settings of the display electronics is missing.	Insert the data storage module (DSM) in the socket on the power supply board.

If it is not possible to rectify a problem, please return the unit for repair together with a short error description, the ambient conditions and the period of use until the problem appeared.

**IMPORTANT! Error message: Parameter is inconsistent!**

To recall a list of all inconsistencies, first enter a valid password and immediately an invalid password. The control unit will show a complete list of current errors (only once). After entering the correct password, the inconsistent settings can be corrected.

8.3 Return shipment to the manufacturer

Due to legal requirements placed on environmental protection and occupational safety and health and to maintain the health and safety of our employees, all units returned to SIKA for repair must be free of toxins and hazardous substances. That also applies to cavities in the devices. If necessary, the customer must neutralise or purge the unit before return to SIKA.

Costs incurred due to inadequate cleaning of the device and possible costs for disposal and/or personal injuries will be billed to the operating company.

**WARNING! Risk of injury due to insufficient cleaning!**

The operating company is responsible for all damages and harm of any kind, in particular physical injuries (e.g. caustic burns or toxic contaminations), decontamination measures, disposal etc. that can be attributed to insufficient cleaning of the measuring instrument.

☞ Comply with the instructions below before returning the unit.

The following measures must be taken before you send the unit to SIKA for repair:

- ☞ Clean the device thoroughly. This is of extreme importance if the medium is hazardous to health, i.e. caustic, toxic, carcinogenic or radioactive etc.
- ☞ Remove all residues of the media and pay special attention to sealing grooves and slits.
- ☞ Attach a note describing the malfunction, state the application field and the chemical/physical properties of the media.
- ☞ Please follow the instructions on the procedure for sending returns which are on our website (www.sika.net/en/services/return-of-products-rma.html) and please specify a point of contact in case our service department has any questions.

The customer must confirm that the measures were taken by filling out the declaration of decontamination. It can be found on our website as a download:

www.sika.net/images/RMA/Form_return_of_products.pdf

9 Cleaning, maintenance, storage

9.1 Cleaning

Clean the VMM with a dry or slightly damp lint-free cloth. Do not use sharp objects or aggressive agents for cleaning.

9.2 Maintenance

The VMM is maintenance-free cannot be repaired by the user. In case of a defect, the device must be replaced or returned to the manufacturer for repair.

The VMM has no parts which have to be replaced or adjusted regularly.

Even though the units are maintenance-free, it is recommended to check the flow meter for signs of corrosion, mechanical wear and damages at regular intervals.

We recommend routine checks at least once annually.

To clean and visually inspect the electrodes and the interior lining, the unit has to be removed from the pipeline.

CAUTION! Risk of injury!



Perform all installation and connection work only when the supply voltage is switched off.

The connection between sensor and display electronics under voltage must not be disconnected or short-circuited!

↳ Make sure that the plant is shut down professionally.



CAUTION! Risk of injury or material damage!

When removing the unit from the pipeline, take appropriate safety precautions. Always use new gaskets during the new installation in the pipeline.

Mains fuse:

The mains fuse is located in the terminal compartment. Before replacing the fuse, the power has to be switched off. Check carefully that the transmitter is voltage free.

The fuse may only be replaced by the exactly same type of fuse!

Mains fuse:

- 5 x 20 mm (according to DIN 41571-3)
- Rated voltage 250 V AC
- Braking capacity 80 A @250 V AC

$$115/230 V_{AC} = 100 \text{ mA (T)}$$

$$24 V_{DC} = 1 \text{ mA (T)}$$

9.3 Storage

The device is to be safeguarded against dampness, dirt, impact and damage.

- ↪ Store the VMM dry and dust free.
- ↪ Prevent direct, permanent solar radiation and heat.
- ↪ Prevent external loads on the unit.
- ↪ The permissible storage temperatures are -20...60 °C.

10 Disassembly and disposal



CAUTION! Risk of injury!

Never remove the device from a plant in operation.

- ↪ Make sure that the plant is shut down professionally.

Before disassembly:

Prior to disassembly, ensure that

- the equipment is switched off and is in a safe and de-energised state.
- the equipment is depressurised and has cooled down.

Disassembly:

- ↪ Remove the electrical connectors.
- ↪ Remove the VMM using suitable tools.

Disposal:

Compliant with the Directives 2011/65/EU (RoHS) and 2012/19/EU (WEEE)*, the device must be disposed of separately as electrical and electronic waste.



No household waste!

The VMM consists of various different materials. It should not be disposed of with household waste.

Comply with the relevant regulations of your country when disposing the units.

- ↪ Take the VMM to your local recycling plant

or

- ↪ send the VMM back to your supplier or to SIKA.

* WEEE reg. no.: DE 25976360

11 Technical data

The technical data of customised versions may differ from the data in these instructions. Please observe the information specified on the type plate.

11.1 Characteristics of the VMM

Type	VMM32 ...VMM200											
Characteristics Sensor												
Measuring range	0...10 m/s											
- DN ...	15	25	32	40	50	65	80	100	125	150	200	
- from 0 to [m ³ /h]	6.3	17.6	28.9	45.2	70.6	119.4	180.9	282.7	441.7	636.1	1130	
- factory scaled measuring range (0/4...20 mA) from 0 to [m ³ /h]	3	10	10	10	20	50	50	70	100	150	250	
Accuracy *1)	±0.5 % of reading (1...10 m/s) ±0.4 % of reading ±1 mm/s (< 1 m/s)											
Repeatability	±0.15 % (0.25...10 m/s)											
Output signal starting from	> 0 m/s (depending on the electronics settings, for example on low-flow suppression)											
Response time	< 100 ms (depending on the electronics settings)											
Measuring principle	Clocked DC field (DC)											
Mounting position:	→ § 4.3											
- inlet section	5 x nominal width (DN)											
- outlet section	2 x nominal width (DN)											
Characteristics display electronics												
Electrical characteristics:												
Measured value and measured range	Induced voltage of the connected sensor											
Supply voltage	230 V _{AC} (-15/+10 %) • 50/60 Hz 115 V _{AC} (-15/+10 %) • 50/60 Hz 18...36 V _{DC}											
Power consumption	15 VA											
Electrical connection	Terminal strips											
Cable glands												
- Display electronics	M20x1.5 • (plastic)											
- Sockets	M16x1.5 • (metal)											
Display *2)	LCD, backlight											
- Line 1	flow rate in l/min											
- Line 2	flow velocity in m/s											

*1) Reference conditions: Media temperature 10...30 °C; Ambient temperature 20...30 °F; warm-up period 30 min.; straight pipe lengths; inlet 5 x nominal width, outlet 2 x nominal width, regularly centered and grounded.

*2) adjustable via menu.

Type	VMM32 ...VMM200													
Output signal display electronics														
Pulse / Frequency output:														
Signal type (selectable)	Pulse signal or frequency signal													
Signal shape	Square wave signal													
Pulse output														
Pulse rate:	DN	15	25	32	40	50	65	80	100	125	150	200		
- factory-set	[1/m ³]	1000	1000	1000	1000	1000	1000	1000	1000	1000	100	100	100	
- Pulse significance	≤ 1000 Pulse/s													
- Pulse width	≥ 0.1 ms (max. 2s) • adjustable													
Frequency output														
0...1 kHz ¹⁾ :	DN	15	25	32	40	50	65	80	100	125	150	200		
- from 0 to	[m ³ /h]	3	10	10	10	20	50	50	70	100	150	250		
Accuracy	additionally ±0.05 % per 10 K													
Analogue output:														
0/4...20 mA ¹⁾ :	DN	15	25	32	40	50	65	80	100	125	150	200		
- from 0 to	[m ³ /h]	3	10	10	10	20	50	50	70	100	150	250		
Signal current (selectable)	0...20 mA • 4...20 mA (active)													
Current limitation	21.6 mA													
Accuracy	additionally ±0.1 % per 10 K													
Max. load	≤ 600 Ω													
Short-circuit proof	Permanent													
Status output / Frequency output:														
as frequency output	max. 1 kHz													
Version	Optocoupler													
Switching values	U _N 24 V • U _{max} 30 V • I _{max} 60 mA • P _{max} 1.8 W													
Function status output (selectable)	forward flow • reverse flow • MIN flow rate • MAX flow rate • alarm													
Low-flow suppression	3% of the measuring range end value (adjustable: 0...20 %)													
Damping	3 s • 0...60 s (programmable)													
Process variables														
Medium to measure:	Water and other conductive liquids													
- Conductivity	> 20 µS/cm													
- Temperature	Hard rubber:	0...90 °C												
	PTFE (40 bar):	-20...100 °C												
	PTFE (25 bar):	-20...130 °C												
	Process connections													
	Steel:	min. -10 °C												
	Stainless steel:	min. -20 °C												
- Flow velocity	0.25...10 m/s													
- Viscosity	no restrictions													
- Aggregate state	liquid													
- Empty pipe detection	can be activated and deactivated													

¹⁾ factory scaled measuring range for ... corresponds to:

Type	VMM32 ...VMM200											
Process variables												
Ambient temperature	Hard rubber: 0...80 °C PTFE: -20...100 °C Display electronics: -20...50 °C (the readability of the LCD is restricted below 32 °F) Process connections Steel: min. -10 °C Stainless steel: min. -20 °C											
Transportation/storage temperature	-20...60 °C											
Nominal Diameter DN ...	15	25	32	40	50	65	80	100	125	150	200	
Inner diameter												
- Hart rubber [mm]	14.0	27.0	33.3	38.0	48.5	64.3	76.9	102.5	127.7	156.3	205.1	
- PTFE [mm]	14.0	27.0	33.3	38.0	48.5	63.3	75.9	102.5	124.7	152.3	201.1	
Compressive strength												
- EN 1092-1 <i>PN 16 at DN 65 for 8 bolt flanges</i>	PN 40	PN 40	PN 40	PN 40	PN 40	PN 16 PN 40	PN 16 PN 40	PN 16 PN 40	PN 16 PN 40	PN 16 PN 40	PN 10 PN 16 PN 25 PN 40	
- JIS B2220 10K	9.8 bar											
- ANSI B16.5 150RF	19.6 bar (Process connection, steel) 15.9 bar (Process connection, stainless steel)											
Degree of protection (EN 60529)	IP 67											
Corrosion protection class	C2 (slightly contaminated atmospheres, dry climate)											
Dimensions and weights												
- Sensor	→ § 11.3											
- Display electronics	2.4 kg											
Reference conditions according to IEC 770	temperature: T = 20 °C relative humidity: rH = 65 % air pressure: p = 101.3 kPa											

11.2 Materials

Component	Material	Component wetted
Components Sensor		
Housing	Steel	
Coils chamber	Steel	
Measuring tube	Stainless steel	
Measuring tube lining	PTFE or hard rubber	X
Electrodes	Stainless steel 1.4571 or Hastelloy C276	X
Process connections	Steel 1.0460 or Stainless steel 1.4404	
Components display electronics		
Housing	Die-cast aluminium	

11.3 Dimensions and weights

11.3.1 Compact device

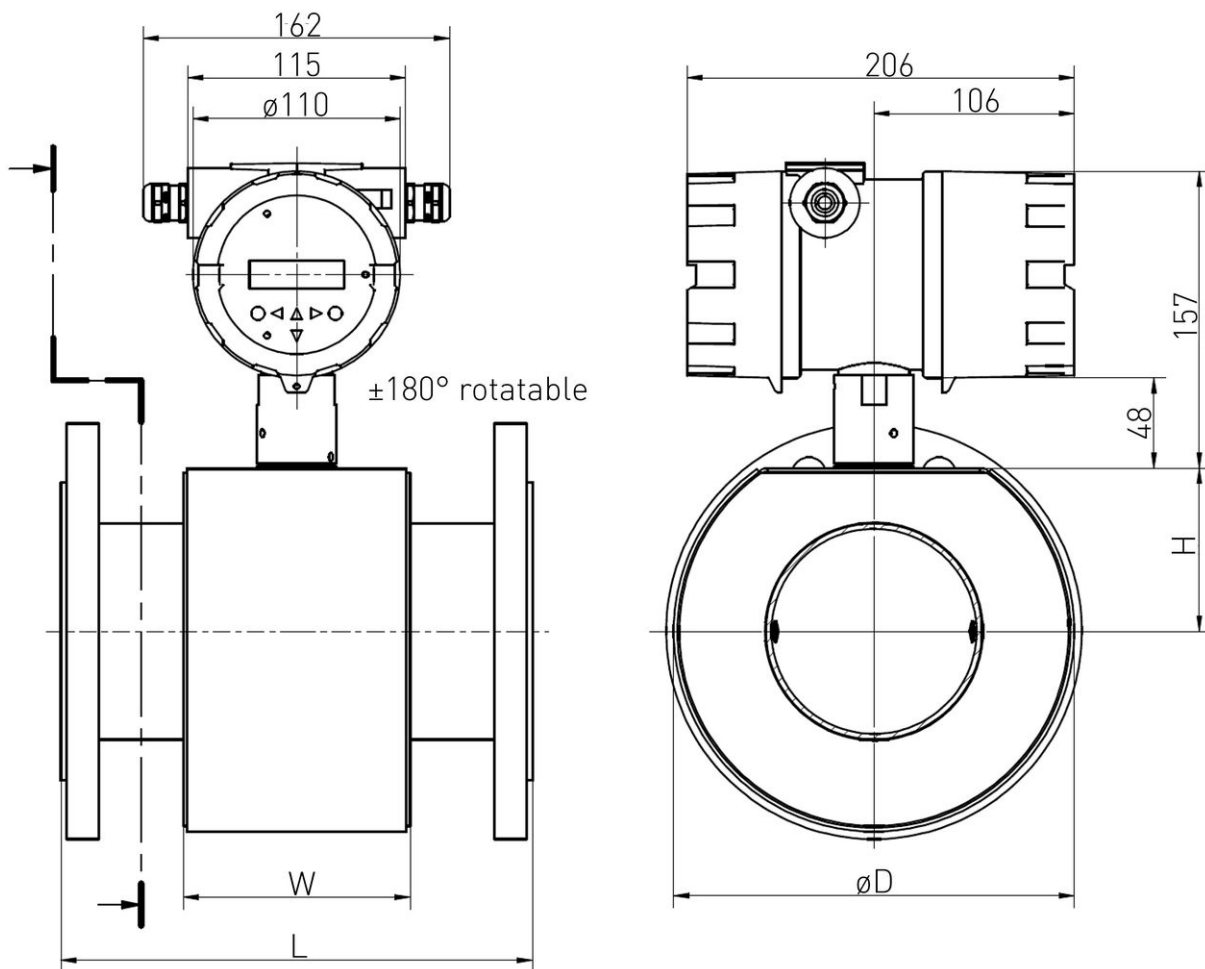

Dimensions [mm]

Process connection		Installation length L			Sensor housing			Weight ¹⁾
EN 1092-1/ JIS B2220 10K	ANSI B16.5 150RF	Hard rubber	PTFE ²⁾	Tolerance	W	D	H	EN 1092-1 [kg]
DN 15	1/2"	200	200 • 206	+0 / -3	80	130	53	5 • 8
DN 25	1"	200	200 • 206	+0 / -3	80	130	53	6 • 9
DN 32	1 1/4"	200	200 • 206	+0 / -3	80	130	53	7 • 10
DN 40	1 1/2"	200	200 • 206	+0 / -3	80	130	53	7.5 • 10.5
DN 50	2"	200	200 • 206	+0 / -3	80	140	57	9 • 12
DN 65	2 1/2"	200	200 • 206	+0 / -3	80	155	63	10 • 13
DN 80	3"	200	200 • 206	+0 / -3	80	170	70	13 • 16
DN 100	4"	250	250 • 256	+0 / -3	120	210	86	15 • 18
DN 125	5"	250	250 • 256	+0 / -3	120	240	98	19 • 22
DN 150	6"	300	300 • 306	+0 / -3	120	285	117	23 • 26
DN 200	8"	350	350 • 360	+0 / -3	200	350	143	36 • 39

¹⁾ Weight: Sensor • Compact device.

valid for DN 15 ... DN 50 (PN 40), DN 65 ... DN 150 (PN 16), DN 200 (PN 10).

²⁾ installation length: without protection ring • with protection ring.

11.3.2 Separate version (with wall bracket)

Display electronics:

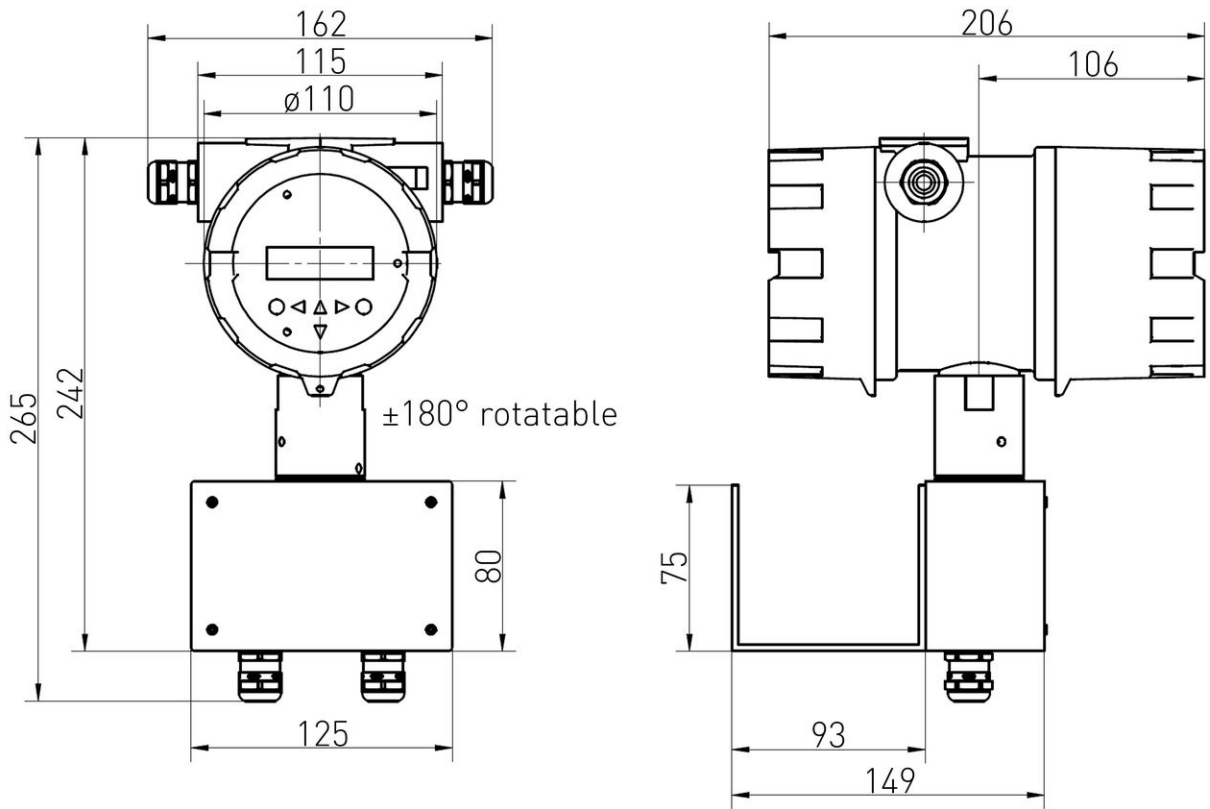

Sensor:

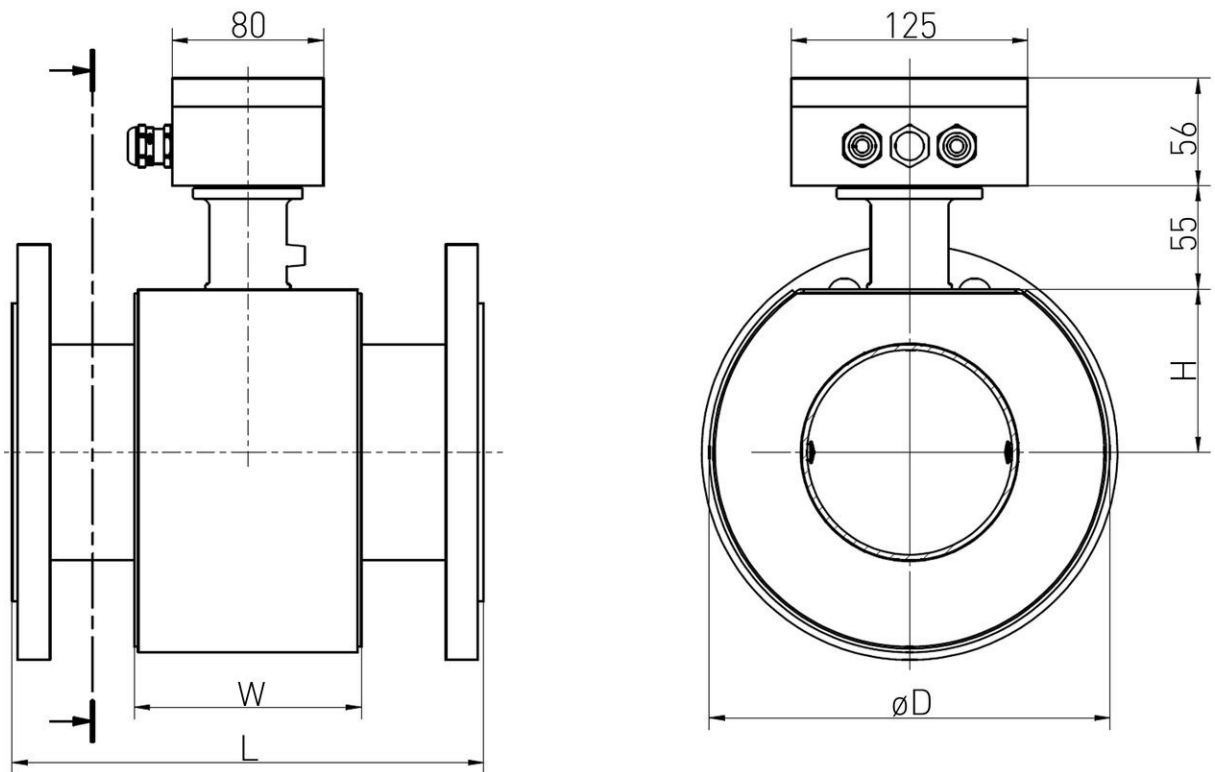

The dimensions L, W, D and H correspond to the values of the table on the compact device (→ § 11.3.1).



Sensors and Measuring Instruments



Flow Measuring Instruments



Test and Calibration Instruments



SIKA Dr. Siebert & Kühn GmbH & Co. KG
Struthweg 7-9
34260 Kaufungen • Germany

☎ +49 5605 803-0
☎ +49 5605 803-555

✉ info@sika.net
💻 www.sika.net